

Air handling by Menerga: Technical catalogue

Swimming pools | Aquaculture |
Net-zero energy buildings (NZEB) | Special applications



Topic overview

About Menerga

Since the company was founded, we have been pursuing our philosophy „We create a good climate - through minimal energy application“ on a daily basis. We are proud to have been one of the first companies in the industry to focus on energy efficiency

from the very beginning and to continue to find new sustainable solutions in the future. Our systems are the result of high-quality, intelligent engineering and craftsmanship.



Technical Information

Casing

- 04 **NX casing**
Next Generation
- 06 **TX casing**
Unit casing for private and small swimming pools

Rating systems and certificates

- 08 **Rating systems and certificates**
The quality of good air
- 10 **Passive house**
Highest energy efficiency

Menerga solutions

- 12 **Adiabatic systems**
What is adiabatic cooling?

Swimming Pool

- 14 **Public swimming pools**
- 20 **NX ThermoCond**
Air handling unit with counter-flow plate heat exchanger
- 24 **NX ThermoCond HP**
Air handling with asymmetric high-performance heat exchanger, integrated capacity-controlled heat pump
- 28 **AquaCond**
Heat recovery from waste water
- 34 **Private and hotel swimming pools**
- 38 **TX ThermoCond / HP**
Air handling with cross-counter-flow plate heat exchanger
- 44 **ThermoCond 23**
Air handling with cross-counter-crossflow heat exchanger

Aquaculture

- 48 **Aquaculture**
- 52 **NX ThermoCond**
Air handling unit with counter-flow plate heat exchanger
- 56 **NX Adsolair**
Air handling unit with double plate heat exchanger and adiabatic evaporative cooling
- 62 **Drysolair**
Air dehumidification unit with cross counterflow plate heat exchanger and heat pump

Minimal Energy Application

With over 40,000 units installed worldwide, we cover almost every area of application. We don't just sell the units, but offer you our years of experience. In the search for the best solution, we analyse the specific conditions on site together with you and

find the optimal solution. Can an alternative energy source perhaps still be used to further reduce operating costs?



Net-zero energy buildings

- 66 **Net-zero energy buildings**
- 72 **Trisolair**
Air handling unit with cross-counterflow-cross heat exchanger
- 78 **NX Adconair**
Air handling unit with counterflow plate heat exchanger
- 88 **NX Adsolair**
Air handling unit with double plate heat exchanger and adiabatic evaporative cooling
- 94 **NX Resolair**
Air handling unit with highly efficient regenerative heat storage packages



Special Applications

- 102 **Special applications**
- 108 **Drysolair**
Air dehumidification unit with cross counterflow plate heat exchanger and heat pump
- 110 **NX Adsolair kitchen**
Ventilation of large kitchens and rooms with polluted exhaust air



Orange is green

- 112 **At a glance**
- 114 **Innovation for the future**
Sustainable air handling by Menerga

Next Generation

New unit casing

After more than 40 years, we are taking the next step with the unit casing. Our new casing meets the highest standards, has a distinctive, practical design and, above all, provides even more flexibility and quality.

Why a new casing?

With our new *Next Generation** case, we have redefined quality standards. The development of the new casing generation has been significantly influenced

by customer wishes and production requirements. And we remain true to our corporate philosophy: Menerga - **Minimum Energy Application**.

What are the new benefits?

Above all, the modular design enables individual use of the ventilation and air-conditioning technology. Our new casing offers numerous advantages such as high flexibility, consistent avoidance of thermal bridges in all areas and easy cleaning thanks to smooth surfaces on the inside.

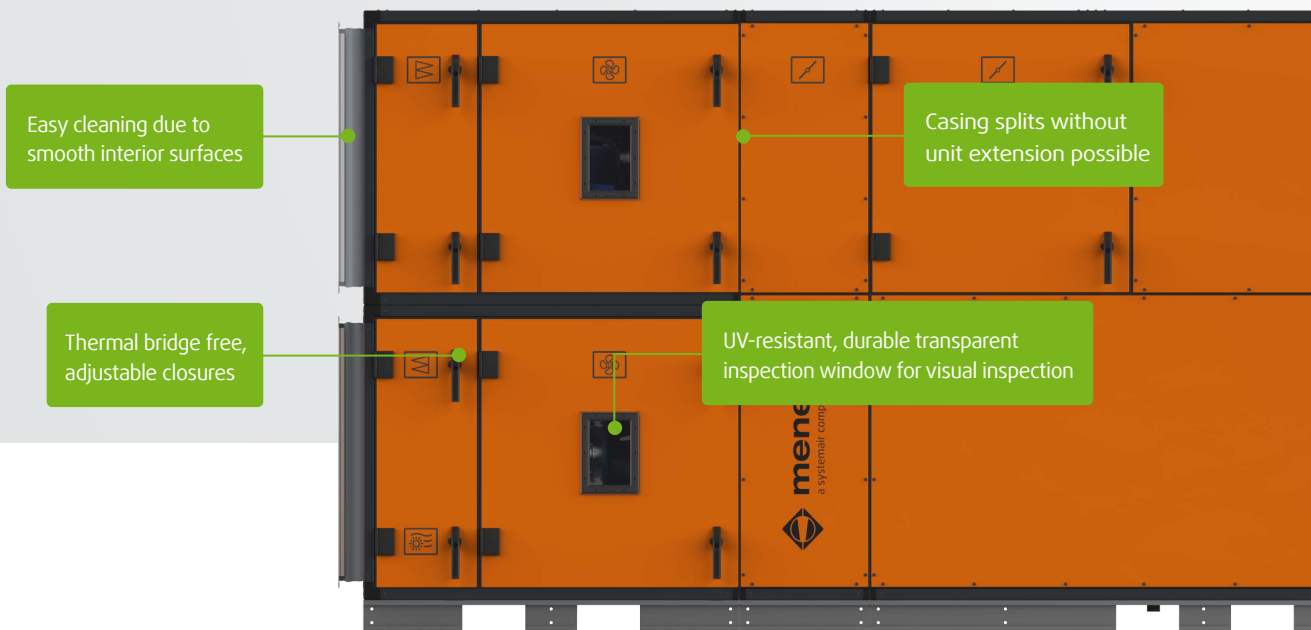

Individual → Modular design

Reliable → Thermal bridge factor TB1 according to DIN EN 1886

Unique → Best characteristics in a wide range of application areas

Will the MB50 casing still be available in the future?

Starting with our core competence, indoor swimming pool air treatment, we will successively adapt our units in the individual application areas. In the meantime, both types of casing are available.

Eurovent Certita Certification is recognized as a world leader in third-party product performance certification in the Heating, Ventilation, Air Conditioning, and Refrigeration fields. Based on a voluntary approach, our certification schemes are open to all manufacturers and distributors.

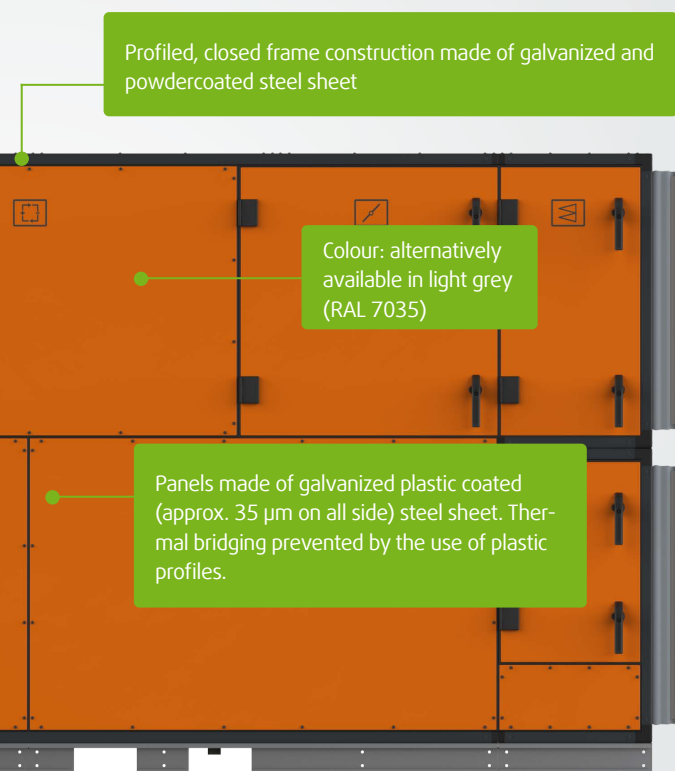

Thermal bridging factor
TB1

Next Generation

Mechanical strength

D1 (M)

Casing leakage

L1 (M)

Filter bypass leakage

F9 (M)

Heat transfer

T2

Thermal bridging factor

TB1

*Certified by Eurovent

TX Casing

New unit casing for private and small swimming pools

Menerga's new TX casing offers even better energy efficiency and an even wider range of application possibilities. Standardised and flexible design reduces lead times and ensures short delivery times and effortless installation. These are a few of the things that make TX not only right for your building's air flow but also for the work flow.

The Menerga control system makes it simple to connect, configure and control TX units and handle multiple units via a cloud service. The TX range comes in five sizes and a variety of standard configurations. It can be combined with re-heaters, domestic heat pump coupling and various control functions.

Simple installation and reassemble on-site

All models are dimensioned for smooth installation.



50 mm thick, self-supporting casing

The mineral fibre insulation provides very good sound insulation and at the same time reduces heat transfer, which eliminates condensation on enclosure parts.

Easy → Selection, assembly and intuitive control system

Compact → Minimum space requirement with efficient performance

Quick → Wide range of standardised units with fast delivery

All TX sizes are available as split units and designed to be easy to dismantle and reassemble on site.

Designed for easy service and maintenance

The design enables easy access for inspection, maintenance and cleaning of all exposed surfaces through the large inspection doors. Construction methods and component materials are selected to easily maintain the interior and functionality of the air handling unit.

A design without exposed sharp edges ensures that surfaces can be safely cleaned. Main components are also easily removable for cleaning and servicing. To allow an comfortable maintainance in small technical rooms the doors can be easily removed.

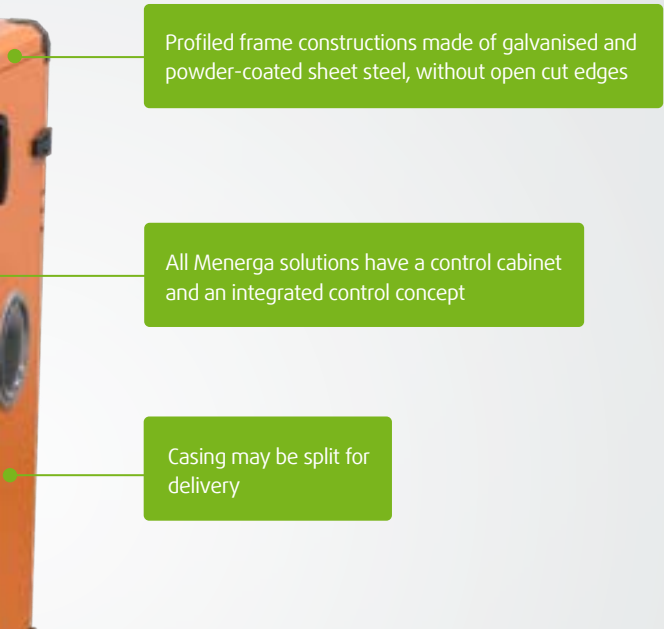

The quality of good air

As a leading manufacturer of air conditioning and ventilation systems, we at Menerga place a special focus on indoor air quality. Our innovative solutions ensure a healthy and pleasant indoor climate in offices, public facilities and industrial plants.

Why is air quality so important?

Optimal air quality is crucial for people's well-being, productivity and health. Poor air can lead to lack of concentration, fatigue and even health problems. That's why Menerga develops solutions that ensure a continuous supply of fresh air and efficiently remove pollutants to create a healthy indoor environment.

Our commitment to sustainability and quality:

At Menerga, customer satisfaction is our number one priority. We are committed to ensuring that our products not only meet the strictest industry standards, but also exceed our customers' expectations. Our environmentally friendly solutions help reduce energy consumption and minimise CO₂ emissions.

More information?

www.menerga.com



Empowering Sustainable Buildings:

At Menerga we are proud to offer innovative high performance air handling units that not only meet the highest technical standards, but also the requirements of the most prestigious building certifications such as LEED, BREEAM and Well Being. Our long-standing expertise and commitment to sustainability enables us to provide solutions that meet the highest standards of building efficiency and environmental performance.



Leed: Leadership in Energy and Environmental Design (LEED) is a green building rating system developed by the U.S. Green Building Council in 1998.



BREEAM®

BREEAM is a rating system for the sustainability of buildings and real estate that has been in practice since 1990. The system was developed to reduce the environmental impact of buildings, improve the quality of life of users and increase the value of real estate in the long term.



Well Building Institute (IWBI) is an international system provider for the WELL Building Standard (WELL), the first rating system that focuses exclusively on the goal of positively influencing the comfort, health and well-being of users through the design of buildings and interior spaces.

Highest energy efficiency

Passive house explained:

The passive house is one of the most energy-efficient forms of construction. A building standard that is energy-efficient, comfortable, economical and environmentally friendly at the same time.

The certification of Passive Houses ensures that the high quality requirements of the Passive House Standard are achieved. This can be seen as an overall concept, as it covers construction right through to operation. This also includes, for example, ventilation systems, which can be certified by the Institute. An essential component in the certification of the entire building is the ventilation units.

These help to ensure that the "passive house criteria" such as the heating energy requirement of no more than 15 kWh/m²-a and the primary energy requirement of less than 120 kWh/m²-a are met with an airtightness of at least n50 = 0.6 /h. To achieve this, not only an airtight construction with very good thermal insulation is necessary, but also highly efficient equipment technology. The compulsory ventilation system must not exceed 0.45 Wh/m³ electrical input power with a heat recovery efficiency of at least 75 % at -10 °C OA and 21 °C RA.

Menerga solutions

Passive House certified components

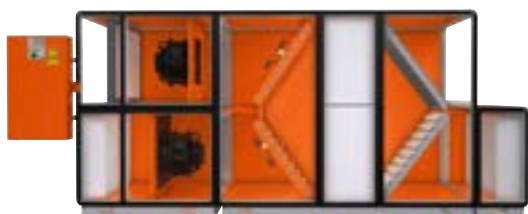

NX Resolair:

Low energy unit with highly efficient regenerative heat storage



NX Adconair:

Low energy unit with counterflow plate heat exchanger

Passive House certified ventilation units:

An essential component of the passive house concept is air treatment with highly efficient heat recovery. Our Menerga Resolair 64 and NX Adconair series are official passive house certified components and are therefore ideal for use in passive houses and all other low-energy buildings.



References

Ideal air conditions for all building types

Air volume flow:
100,000 m³/h



The One in Brussels, Belgium

Air volume flow:
14,300 m³/h



Etrium in Cologne, Germany

Air volume flow:
5,000 m³/h



UN Eco Building in Cologne, Germany

What is adiabatic cooling?

Inspired by nature:

Adiabatic evaporative cooling is a very efficient principle that can be found in nature. It makes use of the physical effect when water evaporates it removes thermal energy from the air, which cools it down. Everybody has experienced this effect themselves, e.g. doing sport and sweating. When the sweat film evaporates on the skin, sensible heat, i.e. heat that you can feel, is taken away and the body temperature falls.

Highest heat recovery rates

Menerga has been applying this principle in highly efficient air-conditioning technology for over 30 years. The air temperature can be lowered by up to 12 K by means of conventional evaporative cooling,

without any energy input for cooling. Physically, however, there are limits to evaporative cooling, which are related to the respective wet-bulb temperature. Pure adiabatic systems cannot achieve a lower supply air temperature than about 20 °C. In hot summer months, therefore, an additional compression refrigeration system with significantly higher energy and maintenance costs, was typically the only solution.

Even higher energy savings

Menerga has now managed to expand the capacity limits of adiabatic systems. For many applications, a separate compression refrigeration system is no longer needed!

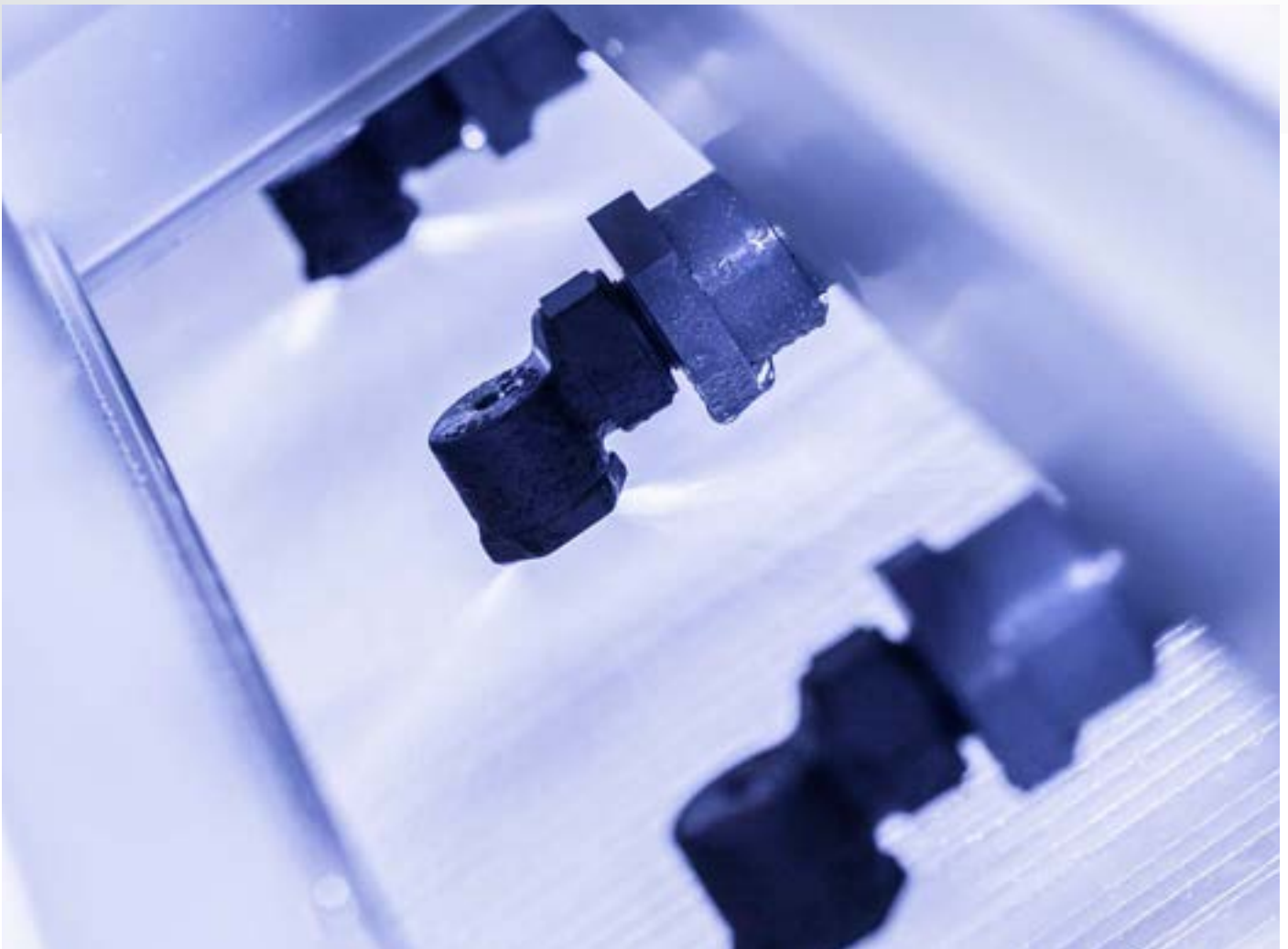

Save energy and operating costs

From an economic standpoint as well, adiabatic systems pay off for the system owner. Low power consumption reduces operating costs. Furthermore, the elimination of the compression refrigeration system, means a reduction in maintenance and regular leakage tests (as required under F-Gas regulations). There is also official legislation to limit the quantity (phase-down) of FC on the market before 2035, meaning that the new technology developments in adiabatic cooling pose no cost risk for the future.

The best choice Adiabatic variants

All variants at a glance	Supply air temperature	Outdoor air dehumidification	Extract of sensitive loads (heat)	Extract of latent loads (humidity)
Adconair Adiabatic integrated evaporative cooling	20 °C	-	+	+
Adconair Adiabatic^{zeroGWP} hybrid evaporative cooling	18 °C	-	++	++
Adconair AdiabaticDX^{carbonfree} thermally driven integrated adsorption process on the basis of water	< 18 °C	up to 4 g/kg	+++	+++





Area of Application: Swimming Pool

- 14 **Public swimming pool:**
Information
- 20 **NX ThermoCond**
Air handling unit with counter-flow plate heat exchanger
- 24 **NX ThermoCond HP**
Air handling with asymmetric high-performance heat exchanger, integrated capacity-controlled heat pump
- 28 **AquaCond**
Heat recovery from waste water

Indoor swimming pool air treatment and its special features

We offer solutions for private swimming pools, public swimming pools, adventure pools, sports pools, brine pools, hotel pools, school swimming pools, therapy pools and many more. Additionally: heat recovery from waste water.



Save energy costs: The costs of water, energy and maintenance for the operation of an indoor swimming pool are rising year by year. Any opportunity to make savings has to be used to keep entrance fees stable. The use of highly efficient technology reduces the energy demand significantly.

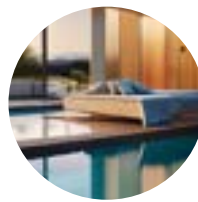

Sense of well-being: The room air temperature is usually 2-4 °C higher than the pool water temperature, but not higher than 34 °C. This small temperature difference is practically imperceptible to the user. The temperature and humidity in the pool hall contribute greatly to the well-being of the user. The absolute water content in the swimming hall plays an important role.



Protect the fabric of the building: Due to the constant evaporation of water from the pool surface, dehumidification of the indoor swimming pool air must be ensured around the clock, even in idle mode, in order to avoid damage to the building shell or other components.



Healthy air: The process of water treatment can lead to a concentration of disinfection by-products in the hall air. These can be removed from the swimming hall by a ventilation system in combination with a well-designed air distribution system.

Highest heat recovery rates

The air conditioning of swimming pool halls is one of the most demanding segments of air conditioning. This is where we started in 1980, this is where we grew up and this is where we are the market and innovation leader. Our special expertise: Highest heat recovery rates reduce operating costs, robust system designs survive the most adverse conditions.

Comfortable indoor climate

Modern indoor swimming pools offer guests much more than just an opportunity to swim. Fresh air increases the guests' sense of well-being. Around the pool, lounging areas invite guests to rest and relax. The associated long duration of the guest's stay, even outside the pool, increases the demands on the indoor swimming pool climate.

Due to the permanent evaporation of the pool water and in order to maintain the comfort criteria, indoor

swimming pool dehumidification is required. Modern control systems ensure continuous adjustment of the swimming pool hall temperature and humidity and the amount of outside air required for dehumidification.

Protecting the building

In addition to the comfort requirements of the bathers, the protection of the building fabric is of enormous importance. A well thought-out air distribution system ensures that air is mixed in all areas of the swimming hall. This prevents the formation of moisture pockets and thus a possible fall below the dew point on building surfaces. Regardless of the intensity of use and the type of swimming pool hall, 24-hour operation of the air handling unit is always necessary. The selection of a highly efficient dehumidification unit is decisive for keeping the operating costs in a swimming pool hall low.

Our advisory process starts with a deep understanding of your requirements, challenges and goals. We listen attentively, carefully analyse your needs and then create customised solutions that are precisely tailored to your situation. We always place great emphasis on efficiency, sustainability and cost-effectiveness.

Request a personal consultation:

mypool@menerga.com

Unit overview



Indoor swimming pool

TX ThermoCond

TX ThermoCond HP

→ Coupling water-air temperature

→ Domestic heat pump operation
→ Pool water condenser in titanium design
→ Coupling water-air temperature

Further versions

			TX ThermoCond	TX ThermoCond HP
Private swimming pools		One's own wellness oasis is used for relaxation and needs special protection - with all its different demands.	+++	+++
Public pools	Swimming pool	For the public sector, the focus is on energy efficiency and the associated reduced operating costs.	+	++
	Competition pools	These often multifunctional halls also require multifunctional facilities.	+	++
	Wellness Center	Maximum comfort in the different climate zones within the centre is the top priority here.	+	+++
	Leisure pool	Whether big or small - only a satisfied customer likes to come back. Fun and well-being are in the foreground here.	+	++
	Passive house swimming pool	Swimming pools are also increasingly being built in passive house design. This results in new challenges for ventilation technology.	+	+
	Therapy bath	A very high heat demand requires one thing above all: high-performance heat recovery.	+	++
	Hotel swimming pool	Compact units are preferred! The smallest possible footprint is an advantage here.	++	+++
	Heat recovery from waste water	Here, no heat from shower water and the like is thrown away. This has been an integral part of our swimming pool technology for 40 years.		
Side rooms	Changing rooms and many other rooms	In the changing rooms, bathers move around both lightly and fully clothed. This is a particular challenge for the ideal climate.	++	+

- + Good
- ++ Excellent
- +++ Best in Class

**ThermoCond 23**

→ Coupling water-air temperature

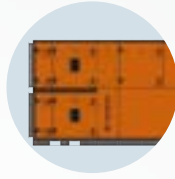
**NX ThermoCond**

→ Indoor and outdoor installation
→ Fresh water heater
→ Short design of the recuperator

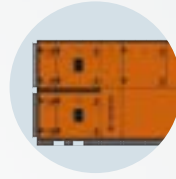
**NX ThermoCond HP**

→ Indoor and outdoor installation
→ Reversible heat pump
→ Pool water condenser in titanium design
→ Refrigerant subcooler for fresh water heating

**AquaCond**

→ Pre-filtering of the waste water with coarse filters
→ Recuperator bypass
→ Safety heat exchanger, for additional separation of fresh and waste water

++

+

+

++

+++

+++

+++

+

+++

+++

+++

++

++

+++

+++

+

++

+++

+++

++

+++

+

+++

+++

+++

+++

+++

++

+

+

+++

+++

+++

+

All-in-one concept: Air handling unit with counterflow plate heat exchanger

NX ThermoCond

- Area of application:** Public swimming pools, leisure pools, sports pools, brine pools, hotel pools, school swimming pools, therapy pools and many more.
- Main functions:** Complete unit - includes all components for heating, dehumidification and ventilation of swimming pools, including all switching and control elements.
- Knowledge:** This complete unit contains all components for ideal heating, dehumidification and ventilation of the swimming pool hall. The units of the NX ThermoCond series achieve a very high passive energy efficiency, as the integrated control and regulation determines the minimum proportion of outdoor air that is required for dehumidifying the indoor swimming pool air. The integrated counterflow plate heat exchanger achieves the highest heat recovery rates with a real counterflow proportion of 80 %. Optionally, the units can be equipped with a fresh water heater for even more efficient use of the heat energy contained in the extract air.

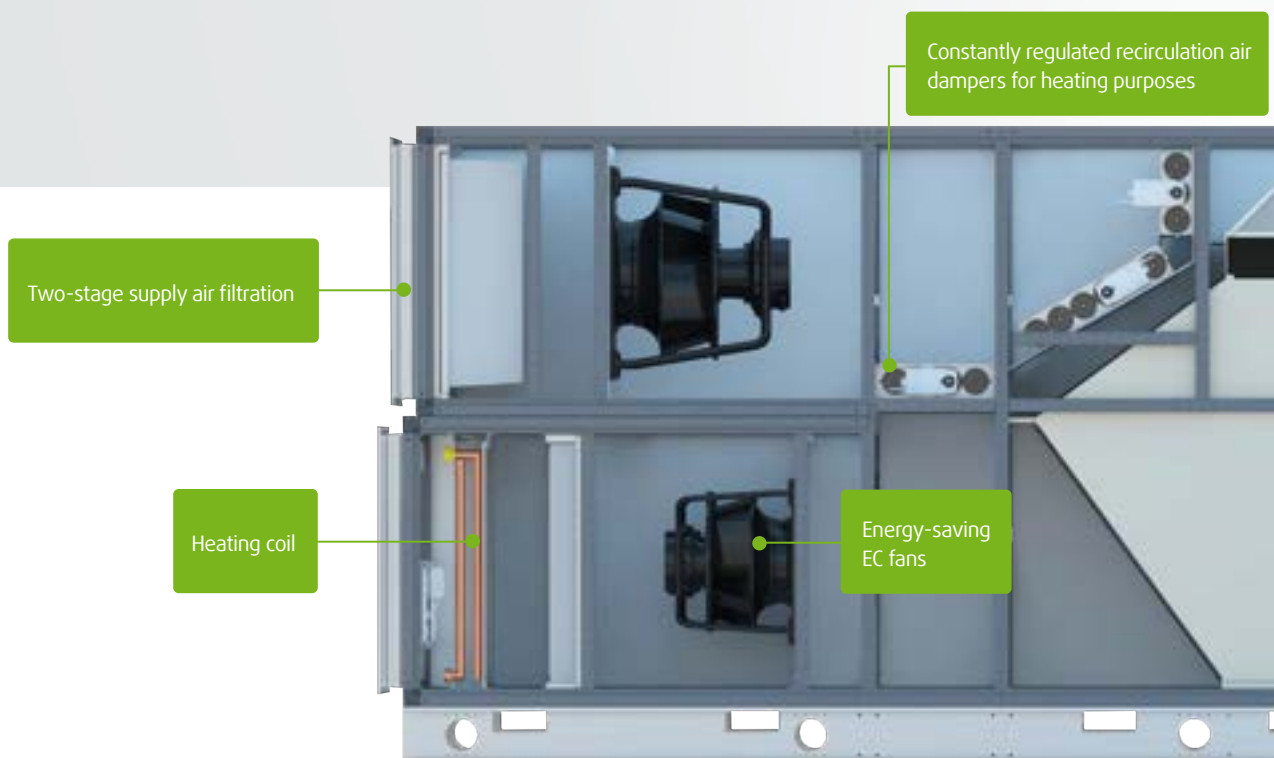

Air volume flow:
2,730 - 37,000 m³/h

Additional details

Included performance parameters:

- Corrosion-free counterflow plate heat exchanger made from polypropylene
- Heating coil
- Air filtration in all operating conditions, with filters in return, outside and supply air
- Constantly regulated recirculation air dampers for heating purposes
- Integrated freely programmable control and regulation unit
- Intensive quality inspection with factory test run
- Complete cleaning of the heat exchanger possible without dismantling

Additional options:

- Recuperator in shortened design
- Attenuator
- Outdoor installation
- Remote maintenance
- Fresh water heater
- Various BMS versions possible
- Your contact person is available for further possible options

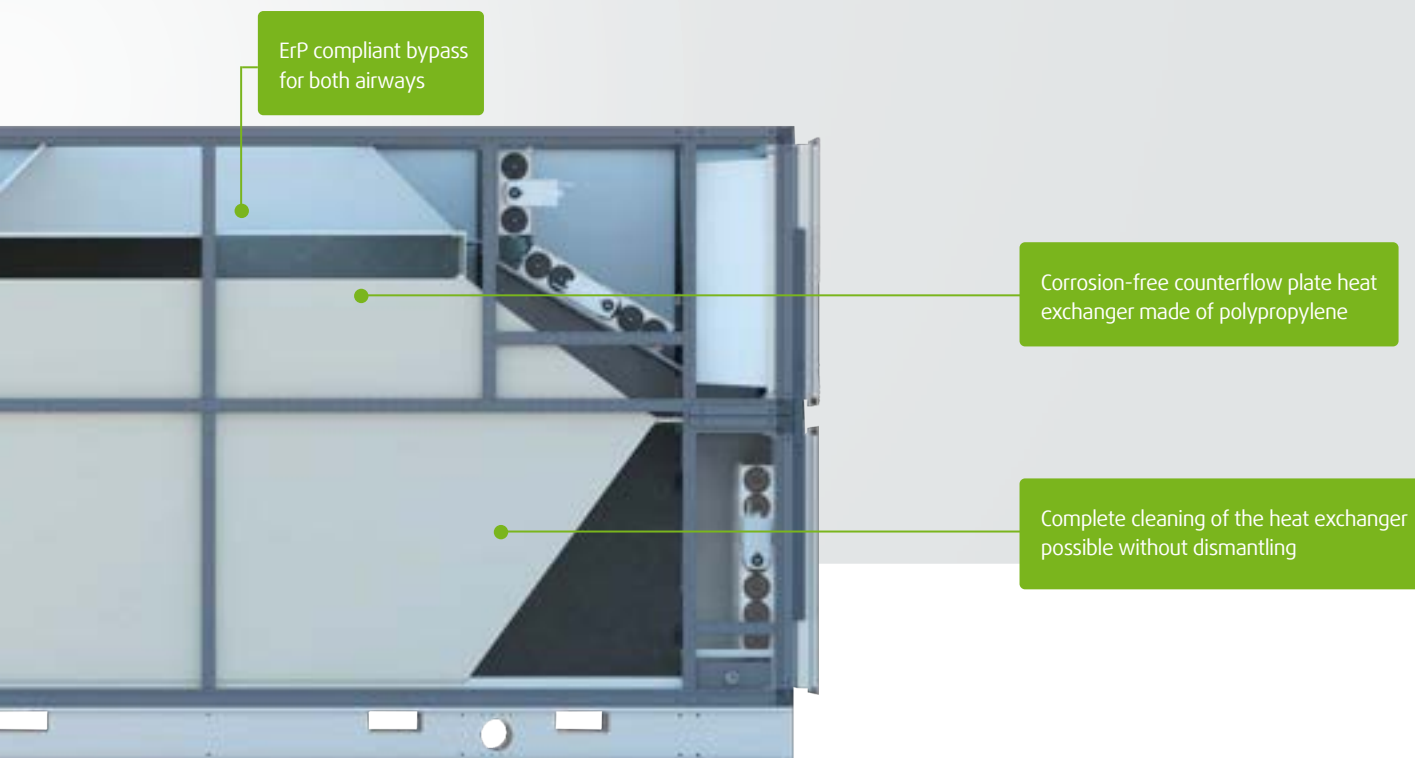

NX ThermoCond

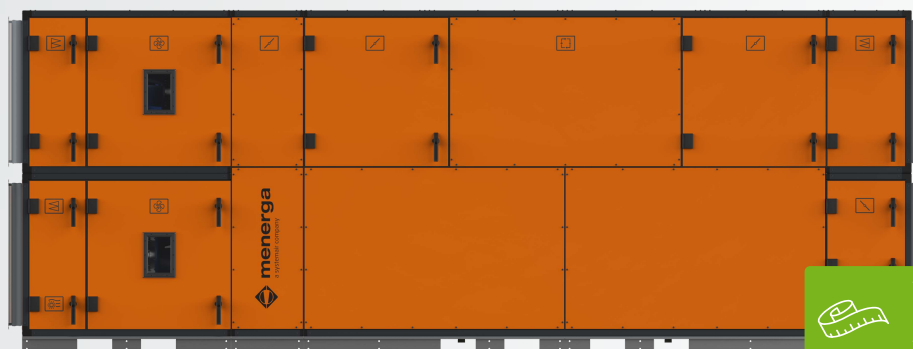

Transport unit still too big? Talk to us.

NX ThermoCond		10.10	15.10	10.15	15.15	20.15	25.15	30.15	30.20	35.20	45.20
Optimum flow rate ¹	m ³ /h	2,730	4,000	4,000	5,840	7,690	9,540	11,380	14,980	17,410	22,270
Volume flow ErP 2018 ^{2,4}	m ³ /h	3,300	4,800	4,850	7,000	9,400	11,850	14,000	18,800	22,200	27,500
Heat recovery efficiency ³	%	87.1	87.5	89.8	90.2	90.4	90.5	90.6	92.7	92.8	92.9
Heat recovery efficiency acc. EN 308	%	75.0	76.0	78.0	78.0	78.0	78.0	79.0	81.0	81.0	81.0
Dehumidification capacity V _{opt}	kg/h	17.3	25.4	25.4	37.1	48.8	60.5	72.2	95.0	110.4	141.2
Dehumidification capacity ErP 2018 ⁴	kg/h	21.0	30.5	30.8	44.4	59.6	75.2	88.8	119.3	140.8	174.4
Max. current consumption ¹	A	11.0	11.0	11.0	14.0	14.0	15.2	20.4	23.0	35.8	35.6
Electrical input power ¹	kW	1.9	2.6	2.6	3.6	4.9	5.7	7.7	10.6	13.6	18.0
Operating voltage		3/N/PE 400V 50Hz									

Connections

	Inch	1 ¼	1 ¼	1 ¼	1 ½	1 ½	1 ½	1 ½	2	2 ½	2 ½
LPHW connection	Inch	1 ¼	1 ¼	1 ¼	1 ½	1 ½	1 ½	1 ½	2	2 ½	2 ½
LPHW control valve connection	DN	15	15	15	20	25	25	25	32	32	32
Condensate drainage	DN	40	40	40	40	40	40	40	40	40	40
Floor drain	DN	20	20	20	20	20	20	20	20	20	20
Clean water heater ⁵	DN	15	15	15	15	15	15	15	15	15	15

Sound power level

Acoustic pressure 1 m from unit ¹	dB(A)	57	56	56	57	59	57	61	62	63	69

Dimensions (with standard configuration)

	mm	5,332	5,332	6,032	6,182	6,182	6,432	6,432	6,782	7,032	7,032
Length	mm	5,332	5,332	6,032	6,182	6,182	6,432	6,432	6,782	7,032	7,032
Width	mm	782	1,082	782	1,082	1,382	1,682	1,982	1,982	2,282	2,882
Height	mm	1,842	1,842	2,442	2,442	2,442	2,442	2,442	3,042	3,042	3,042
Weight	kg	1,128	1,364	1,490	1,857	2,180	2,631	2,924	3,622	4,209	5,135

Largest transport unit

	mm	3,000	3,000	3,600	3,600	3,600	3,600	3,600	4,100	4,100	4,100
Length	mm	3,000	3,000	3,600	3,600	3,600	3,600	3,600	4,100	4,100	4,100
Width	mm	782	1,082	782	1,082	1,382	1,682	1,982	1,982	2,282	1,441
Height	mm	1,842	1,842	2,442	2,442	2,442	2,442	2,442	3,042	3,042	3,042
Weight	kg	617	766	902	1,109	1,327	1,614	1,765	2,315	2,627	3,276
Weight of transport unit	kg	106	129	124	153	182	211	240	279	312	378
Weight of transport unit	kg	79	92	106	120	134	148	162	197	212	253
Weight of transport unit	kg	405	469	464	595	671	806	919	1,028	1,270	1,481

¹ At air velocity 1.8 m/s

² Depending on unit equipment and installation height

³ At OA = -12 °C / 90 % r.h.; EA = 30 °C/53.7 % r.h.

⁴ Upper volume flow rate limit for compliance with EU Regulation 1253/2014

⁵ Optional equipment

All air volume flows are based on standard density 1.2 kg/m³ at OA = 15 °C/85 % r.h.; EA = 30 °C/53.7 % r.h., unless otherwise stated.

Functional description

Description

Standby mode:

No requirements for temperature and dehumidification, unit operates in pure recirculation mode. The aim is air circulation with reduced fan power.

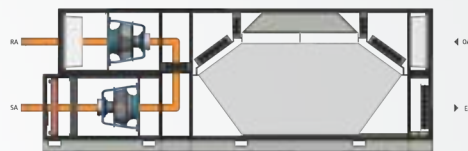

Recirculation mode Heating:

Heating as required via heating coil. The fresh air and exhaust air dampers are closed.

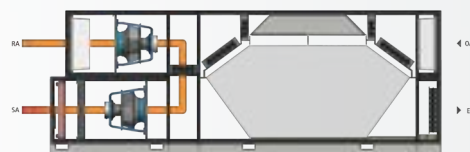

Dehumidification on the unit with counterflow heat exchanger:

Dehumidification of the indoor swimming pool air through demand-dependent mixing of outside air (minimum necessary outside air quantity during bathing operation according to VDI 2089 or local regulations) to the recirculation air volume flow. If necessary: Reheating of the supply air.

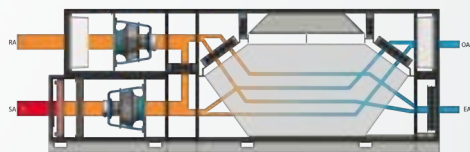

Fresh air / exhaust air mode:

As the outdoor air humidity rises, the recirculation damper is closed as required. When the outdoor humidity is high, the damper closes completely and the unit operates in outdoor air exhaust mode.

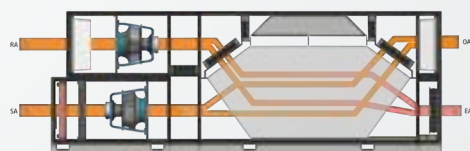

Defrost mode:

Recuperative heat exchangers tend to ice up at low outdoor air temperatures. This is prevented by opening the extract air/extract air bypass as required. The fresh air supply is not interrupted in the process.

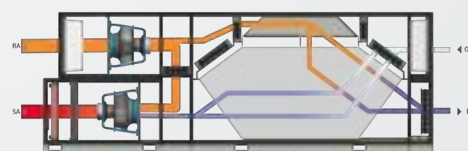

Heat exchanger bypass:

The proportion of air routed via the heat exchanger and the bypass can be regulated up to free cooling.



All-in-one concept: Air handling unit with heat exchanger and integrated capacity-controllable heat pump

NX ThermoCond HP with heat pump

- Area of application:** public swimming pools, adventure pools, sports pools, brine pools, hotel pools, school swimming pools, therapy pools and many more
- Main functions:** Complete unit - includes all components for heating, dehumidification and ventilation of swimming pools, including all switching and control elements.
- Knowledge:** The NX ThermoCond HP achieves a very high energy efficiency, as the integrated control and regulation only mixes in the actual proportion of outdoor air that is needed to dehumidify the indoor swimming pool air. The overall efficiency of the system is additionally increased by the integrated output-controllable heat pump.

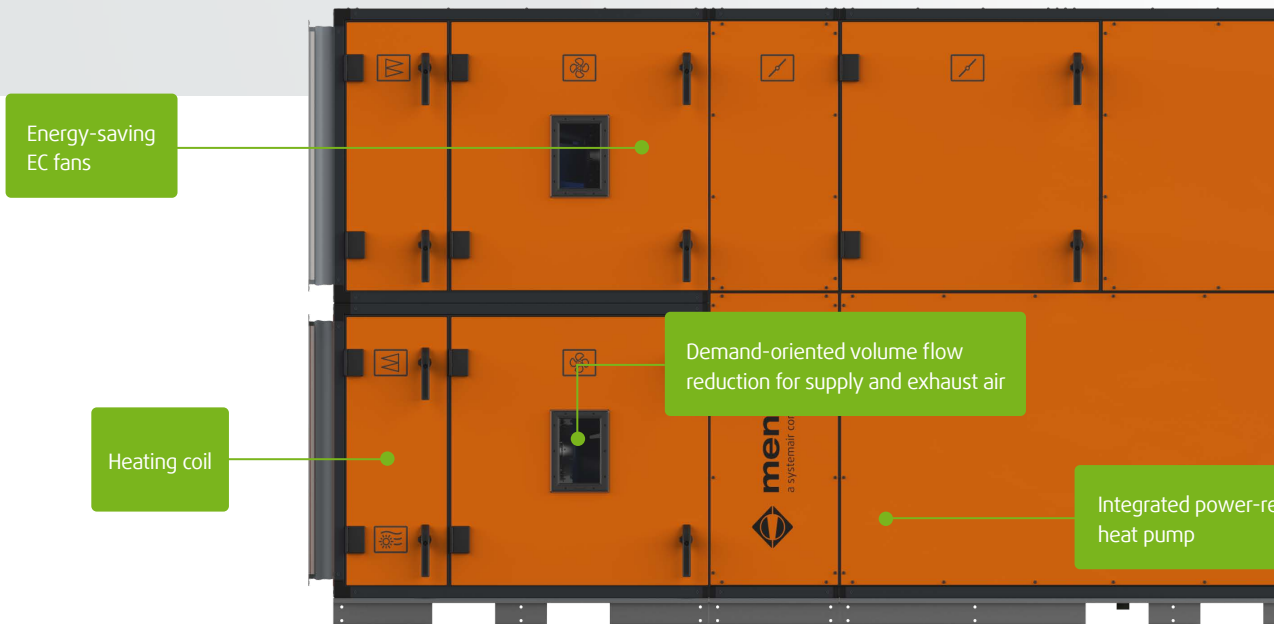

Air volume flow:
2,730 - 37,000 m³/h

Additional details

Included performance parameters:

- Modular design with high variability
- Filtering of the air in every operating mode
- Heating coil
- Individually adjustable performance parameters
- Intensive quality inspection with factory test run

Additional options:

- Pool water condenser
- Heat recovery bypass function
- Dehumidification in recirculation mode
- Dehumidification of fresh air by means of additional fresh air and exhaust air outlets
- Fresh water heater
- Silencer
- Outdoor installation
- Remote maintenance

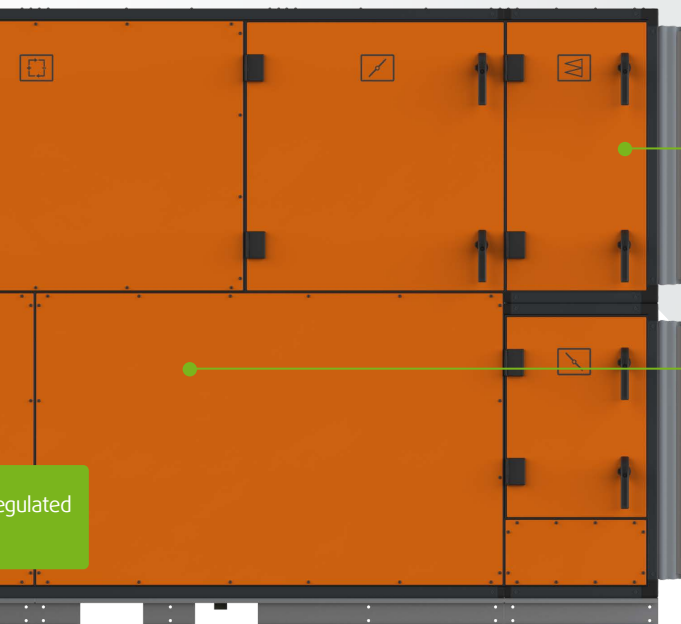

NX ThermoCond HP with heat pump

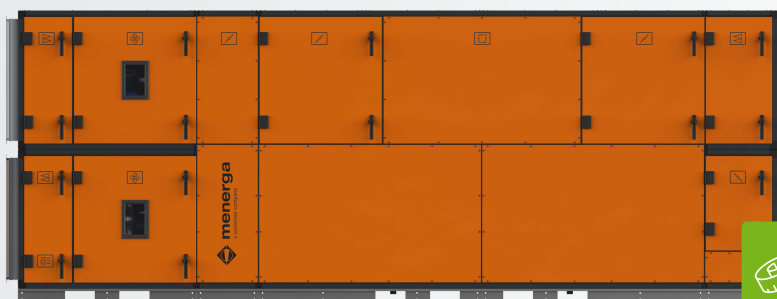

Transport unit still too big?
Talk to us.

NX ThermoCond HP		10.10	15.10	10.15	15.15	20.15	25.15	30.15	30.20	35.20	30.25	35.25	45.20
Optimum flow rate ¹	m ³ /h	2,730	4,000	4,000	5,840	7,690	9,540	11,380	14,980	17,410	18,580	21,590	22,270
Max. volume flow rate ²	m ³ /h	4,200	6,300	6,300	9,500	12,700	15,900	19,000	23,400	29,700	31,000	37,100	37,100
Energetic efficiency ³	%	95.6	101.6	106.1	96.1	91.7	92.2	95.6	100.6	101.1	98.6	99.1	98.5
Heat recovery efficiency acc. EN 308	%	52	51	58	58	57	57	57	64	64	64	64	64
Dehumidification capacity V _{opt} ⁴	kg/h	17.3	25.4	25.4	37.1	48.8	60.5	72.2	95.0	110.6	110.4	137.2	141.4
Dehumidification capacity V _{max} ⁴	kg/h	26.7	40.0	40.0	60.4	80.7	101.0	120.7	148.6	188.6	197.0	235.7	235.5
Heat pump heating capacity	kW	12.1	20.5	20.1	22.2	26.1	33.0	43.7	55.2	65.0	65.5	77.2	77.3
Heating capacity fresh water heater	kW	2.3	3.0	3.1	3.9	4.4	5.4	7.3	9.3	10.5	10.3	13.3	13.2
Max. current consumption ¹	A	18.0	22.8	22.8	25.8	29.0	31.4	42.0	54.0	64.6	64.6	72.2	72.0
Electrical input power ¹	kW	4.0	6.3	6.3	6.8	8.5	9.9	14.0	18.1	22.8	23.7	27.4	28.3
Operating voltage		3/N/PE 400V 50Hz											

Connections

LPHW connection	Inch	1 ¼	1 ¼	1 ¼	1 ¼	1 ½	1 ½	1 ½	2	2	2	2	2
LPHW control valve connection	DN	15	15	15	20	25	25	25	32	32	32	32	32
Condensate drainage	DN	40	40	40	40	40	40	40	40	40	40	40	40
Floor drain	DN	20	20	20	20	20	20	20	20	20	20	20	20
Fresh water heater (optional)	DN	15	15	15	15	15	15	25	25	25	25	25	25

Sound power level

Acoustic pressure 1 m from unit ¹	dB(A)	58	57	57	57	59	57	61	62	63	63	64	67
--	-------	----	----	----	----	----	----	----	----	----	----	----	----

Dimensions (with standard configuration)

Length	mm	4,082	4,082	4,682	4,882	4,882	4,982	4,982	5,582	5,732	6,882	6,132	5,732
Width	mm	782	1,082	782	1,082	1,382	1,682	1,982	1,982	2,282	1,982	2,282	2,882
Height	mm	1,742	1,742	2,342	2,342	2,342	2,342	2,342	2,942	2,942	3,542	3,542	2,942
Weight	kg	906	1,115	1,239	1,510	1,754	2,048	2,310	2,872	3,362	3,967	3,738	3,984

Largest transport unit

Length	mm	1,700	1,700	2,300	2,300	2,300	2,300	2,300	3,000	3,000	3,500	3,500	3,000
Width	mm	782	1,082	782	1,082	1,382	1,682	1,982	1,982	2,282	1,982	2,282	2,882
Height	mm	359	466	596	695	823	943	1,050	1,440	1,666	1,928	1,747	2,102
Weight of transport unit	kg	156	190	187	229	271	313	356	417	464	564	470	525
Weight of transport unit	kg	391	459	456	586	660	792	904	1,015	1,232	1,475	1,521	1,357

All air volume flows are based on standard density 1.2 kg/m³ at OA = 15 °C/85 % r.h.; EA = 30 °C/53.7 % r.h., unless otherwise stated.

¹ At air speed 1.8 m/s

² Depending on unit equipment and installation height

³ According to EN 13053:2019

⁴ According to VDI 2089

⁵ Optional

Functional description

Description

Stand-by mode

No requirement for temperature or dehumidification, device operates solely in recirculation mode. The aim is air circulation with reduced fan power.

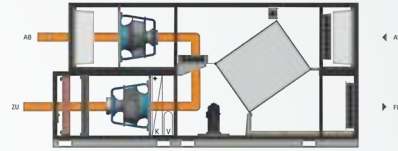

Recirc air heating operation

Heating in accordance with requirements for each heating coil. The outdoor air and exhaust air dampers are closed.

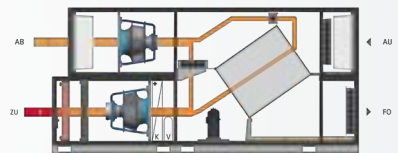

Dehumidification of the device with heat pump

The return air is cooled to below the dew point in the evaporator of the heat pump, reinforced by the recuperator. Outside air with a low moisture content is preheated in the heat exchanger, then mixed with an amount of untreated recirculation air, heated by the condenser and routed into the hall as supply air. If necessary, further heating is carried out with the help of heating coils. During swimming pool mode, the minimum required amount of outdoor air is added as needed.

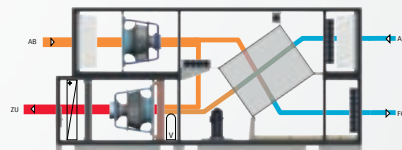

Outside air exhaust air mode

In the case of rising outdoor air humidity, the recirc air damper is closed as required. During high OA humidity, the damper closes completely, the device operates in outside air-exhaust air mode.

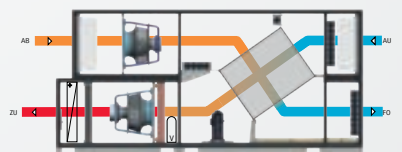

Defrost mode

Recuperative heat exchangers tend to ice up if the outdoor air temperatures are low. This is prevented by opening the return air-exhaust air bypass.

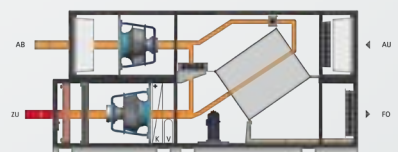

All in one concept: Heat recovery from waste water with counterflow coaxial recuperator and heat pump

AquaCond 44

- 📍 **Area of application:** In the shower areas of swimming pool halls, hospitals or residential homes, in laundries as well as in many industrial processes.
- ⚠️ **Main functions:** Complete unit - includes all components for heat recovery from waste water and efficient heating of fresh water.
- ⚙️ **Knowledge:** All too often, warm wastewater is discharged unused into the sewage system along with the energy it contains. Units of the AquaCond 44 series recover a large part of this heat energy and transfer it to the fresh water. The combination of recuperator and heat pump requires only about 10 % of the energy that conventional heating would require. The heat exchanger cleaning integrated as standard allows the units to be used even with wastewater contaminated with dirt. Recover valuable energy - wherever warm wastewater is produced and warm fresh water has to be provided at the same time.

Flow rate regulation

Automatic heat exchanger cleaning

Quantity of flow:
1.2 – 5.4 m³/h



Additional details

Included performance parameters:

- Automatic heat exchanger cleaning
- Constant pipe cross-sections in the waste water path for constant flow velocity
- Heat pump system with fully hermetic suction gas-cooled refrigerant compressor, on anti-vibration mounting
- Complete unit ready for connection, contains all components for heat recovery from waste water, including all switching and control elements
- Intensive quality inspection with factory test run

Additional options:

- Design of the heat exchanger as a safety heat exchanger, for additional separation of fresh and waste water
- Recuperator bypass
- Version without heat pump
- Also suitable for immersion pool cooling
- And many more



Integrated control and regulation system, compatible with all conventional building management systems

Reduction of energy required to heat the fresh water by up to 90 %



Heat recovery from wastewater with counterflow coaxial recuperator and heat pump

AquaCond 44

The function of an AquaCond unit is to heat cold fresh water to domestic water temperature in an energy-efficient manner. Energy from warm wastewater serves as the heat source. The heat is transferred by combining a recuperative heat exchanger with a heat pump.

In the first step, the warm waste water flows through the recuperator and then through the evaporator of the heat pump. In the opposite direction and in a

separated path, the same amount of fresh water flows first through the recuperator and then through the condenser of the heat pump. In the recuperator, a large part of the heat contained in the waste water is transferred to the cold fresh water. This process takes place in an efficient countercurrent process and does not require any energy input. In the evaporator of the heat pump, a further part of the heat is extracted from the wastewater and transferred to the already preheated fresh water in

the condenser of the heat pump. Due to the optimal coordination of the individual components, a total coefficient of performance of 11 is achieved.

Constant pipe cross-sections in the waste water path guarantee uniformly high flow velocities. This reduces the build-up of dirt in the heat exchanger tubes and thus a deterioration of the heat exchanger efficiency by the very design. Despite the uniform flow, there is a possibility that soaps, greases

Functional description

Heat recovery phase

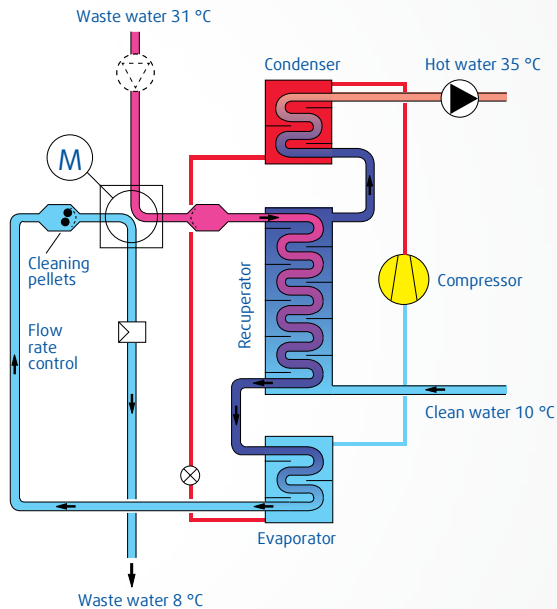

Cleaning phase

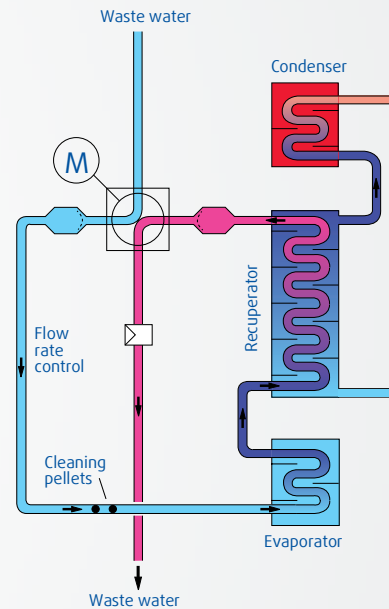

and other substances dissolved in the warm waste water will settle on the heat exchanger surfaces during the cooling phase.

vent the formation of dirt on the surfaces.

If the waste water is organically contaminated, bacteria can grow and sludge can form on the surfaces of the heat exchangers. To prevent this, the automatic heat exchanger cleaning system feeds cleaning pellets through the waste water paths at regular intervals. The cleaning pellets loosen the deposits from the pipes and pre-

AquaCond 44

AquaCond 44		44 12 21	44 18 21	44 24 22	44 36 22	44 54 23
Max. quantity of flow	m ³ /h	1.2	1.8	2.4	3.6	5.4
Heating capacity	kW	37	52	74	104	156
Rated compressor input	kW	2.6	3.4	2 x 2.6	2 x 3.4	3 x 3.4
Combined COP ¹	COP	11.4	11.8	11.5	11.6	11.8
Filling volume for refrigerant type R407C	kg	4.0	5.0	8.0	10.0	15.0
Max. connection capacity	kW	6.4	9.6	13.0	20.0	29.0
Operating voltage		3 / N / PE 400 V 50 Hz				
Residual head fresh water side	kPa	5	5	5	5	5
Pressure losses on the waste water side	kPa	90	90	95	95	98

Connections

Waste water	DN	32	40	40	50	50
Clean water CU	DN	22	28	28	35	35
Clean water PVC	DN	32	32	40	50	50

Dimensions und Weight

Length	mm	1,210	1,370	2,420	2,740	4,110
Width	mm	890	890	890	890	890
Height	mm	1,530	1,690	1,530	1,690	1,690
Weight	kg	450	650	860	1,260	1,900
Controls cabinet ²	mm	900 x 480 x 210		1,120 x 640 x 210		1,600 x 640 x 250

Largest transport unit

Length ³	mm	1,210	1,370	1,210	1,370	1,370
Width	mm	890	890	890	890	890
Height	mm	1,530	1,690	1,530	1,690	1,690
Weight	kg	450	650	460	660	770

For dimensions, please note body dimensions and electrical cabinet. Height without feet. Weight incl. control cabinet. All pipelines must be fitted with shut-off devices on site.

Fittings increase unit width by 25 mm per operating side. Technical data refers to max. flow rate and waste water temperature 31 °C/fresh water temperature 10 °C.

¹ Power consumption incl. domestic hot water pump and external waste water pump

² Position on the unit: Front side on the right

³ Width and height see overall dimensions

AquaCond 44



AquaCond 44 Double axis



Height plus unit feet
Unit feet 100 mm

Additional option: height adjustment from 100 to 120 mm





Area of application: Private and hotel swimming pools

34 **Private and hotel swimming pools:**
Information

38 **TX ThermoCond / HP**
Air handling with cross-counter-
flow plate heat exchanger

44 **ThermoCond 23**
Air handling with cross-counter-
crossflow heat exchanger

Important facts

Private indoor swimming pool air treatment and its special features

Nowadays, your own indoor swimming pool often offers the comfort of a wellness oasis and a fitness facility in one. This makes a swimming hall a place of retreat to escape the stress of daily life. Especially in a private swimming hall, the main focus is on the feel-good factor.



Best air conditions for maximum relaxation

The air quality in the swimming pool hall determines the extent of relaxation in the swimming pool hall. Sultry, cold air or even draughts prevent a comfortable climate and quickly deprive the owners of the pleasure of swimming.

The building structure is protected

Particularly in a private swimming hall, the main focus is on the feel-good factor. A comfortable climate in the swimming pool hall plays a major role in this. Not only by the interaction between room temperature and humidity, but also the air circulation, which must be perfectly matched to the room conditions. This is because draughts or misted-up windows due to condensation must be avoided.

The ventilation system must ensure that the air circulates evenly in the swimming pool hall. This circulation is important for two reasons. On the one hand, the air transfers the heat to all components so that condensation on colder components is avoided.

Hygienic room air without unpleasant odours

On the other hand, a uniform movement of the air in the swimming pool hall ensures that the by-products released from the water during evaporation can be removed via the ventilation system. Due to the constant evaporation of water from the surface of the pool, the air in the indoor swimming pool must be dehumidified around the clock, even when the pool is not in use, in order to prevent damage to the building shell or other components.

High energy demand is minimised

To maintain a comfortable indoor swimming pool climate, indoor swimming pool units are used that enable dehumidification using outside air. Modern control systems in conjunction with a well-designed unit not only ensure a constant condition of the swimming pool hall, they also contribute to a comfortable and healthy climate with a sensibly controlled and demand-dependent outdoor air operation. A highly efficient heat recovery system reduces the energy requirement for dehumidifying the swimming pool hall to a minimum.

All in one concept: Air handling unit with cross-counterflow heat exchanger for private swimming pool halls

TX ThermoCond and TX ThermoCond HP with heat pump

- 📍 **Area of application:** Private wellness area, home spa, small indoor swimming pool
- ⚠️ **Main functions:** Complete unit - includes all components for heating, dehumidification and ventilation of the swimming pool hall.
- ⚙️ **Knowledge:** The *TX ThermoCond* units dehumidify and heat the swimming pool hall, any pollutant concentration in the air is minimised. *TX ThermoCond* is suitable for swimming pools with lower heating requirements.
- ⚙️ The *TX ThermoCond HP* is equipped with an integrated heat pump. This increases the overall efficiency of the system and enables the dehumidification of the indoor swimming pool air in recirculation mode. In addition, we are the only manufacturer to offer the option of coupling the system to a domestic heat pump, which heats the private swimming pool to a comfortable indoor climate.

Air volume flow:
740 - 3,310 m³/h

Integrated control and regulation system, compatible with all conventional building management systems

Energy-saving EC fans

Filtering the air in any operating mode



Additional details

Included performance parameters:

- Filtering the air in all operating modes
- Heating coil
- Sound-optimised plastic impellers for even quieter operation
- Bypass damper
- Individually adjustable performance parameters
- Intensive quality testing with factory test run

Additional options:

- Air tracks water control option
- Remote maintenance
- Further versions possible

Additional options for the TX ThermoCond HP:

- Pool water condenser
- Domestic heat pump integration



TX ThermoCond



TX ThermoCond		10	15	20	25	35
Optimum flow rate ¹	m ³ /h	740	990	1,330	1,670	2,330
Max. volume flow ²	m ³ /h	1,040	1,420	1,890	2,370	3,310
Heat recovery rate ³	%	85	85	86	86	86
Heat recovery efficiency according to EN 308	%	73.0	73.0	73.0	73.0	73.0
Dehumidification performance acc. VDI 2089	kg/h	4.7	6.3	8.4	10.6	14.8
Max. power consumption	A	8.2	8.2	8.2	8.0	8.0
Electr. total input power	kW	0.7	0.8	0.9	1.2	1.4
Operating voltage		3 / N / PE 400 V 50 Hz				

Connections

LPHW connection	Inch	¾	¾	¾	¾	¾
LPHW control valve connection	DN	10	10	10	10	10
Condensate drain	DN	20	20	20	20	20

Dimensions

Length	mm	1,575	1,575	1,735	1,735	1,735
Width	mm	615	775	775	935	1,255
Height	mm	1,475	1,475	1,795	1,795	1,795
Weight	kg	315	355	410	455	560

All air volume flows are based on standard density 1.2 kg/m³ at outdoor air = 15 °C/85 % r.h.; extract air = 30 °C/53.7 % r.h., unless otherwise stated.

¹ Upper volume flow rate limit for compliance with EU Regulation 1253/2014.

² Depending on unit equipment and installation height

³ With outside air= -12 °C / 90 % r.h.; RA = 30 °C/53.7 % r.h.

Functional description

Description

Recirculating air operation (heating):

If no requirements are placed on temperature regulation or dehumidification when the unit is in standby mode, the system operates only in recirculation mode with reduced air volume flow. The air circulation in the swimming pool hall is guaranteed. If heating is required, the return air is heated up using the heating coil to achieve the supply air temperature set-point.

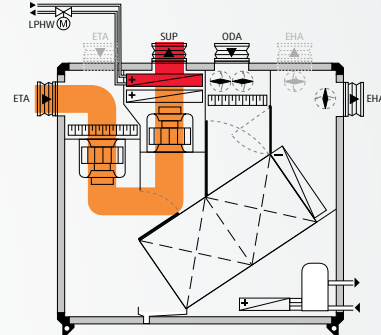

Dehumidification using outside air in winter:

The swimming hall is dehumidified by adding outside air to the recirculation air volume flow. The proportion of outside air is automatically adjusted continuously depending on the current water evaporation (occupancy of the swimming pool hall) and the outside air humidity. If the heat recovery is not sufficient to achieve the supply air temperature, the supply air is reheated by the hot water heating coil.

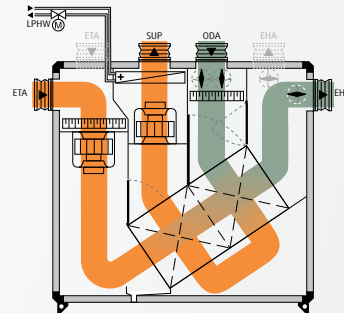

Dehumidification using outside air in summer:

As the outside air humidity rises, the recirculation damper is closed as required. At high outdoor air humidity, the damper closes completely. The unit operates in 100 % fresh air/exhaust air mode via the heat exchanger.

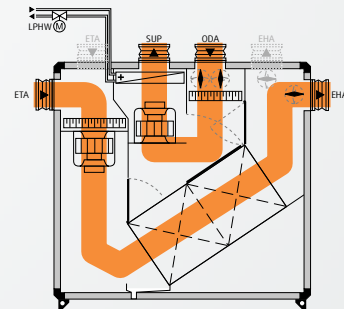

TX ThermoCond HP

with heat pump



TX ThermoCond HP		10	15	20	25	35
Max. volume flow ¹	m ³ /h	1,040	1,420	1,890	2,370	3,310
Heat recovery efficiency ²	%	75	75	78	78	78
Heat recovery efficiency according to EN 308	%	62.0	61.0	65.0	64.0	64.0
Dehumidification performance acc. VDI 2089	kg/h	6.6	9.0	12.0	15.0	21.0
Dehumidification capacity in recirculation mode ³	kg/h	4.4	4.6	6.0	7.2	10.4
Max. power consumption	A	12.4	12.4	13.1	14.3	21.4
Electr. total input power	kW	2.3	2.4	3.3	3.8	5.3
Operating voltage		3 / N / PE 400 V 50 Hz				

Connections

LPHW connection	Inch	¾	¾	¾	¾	¾
LPHW control valve connection	DN	10	10	10	10	10
Condensate drain	DN	20	20	20	20	20

Dimensions

Length	mm	1,575	1,575	1,735	1,735	1,735
Width	mm	615	775	775	935	1,255
Height	mm	1,475	1,475	1,795	1,795	1,795
Weight	kg	400	420	470	515	640

All air volume flows are based on standard density 1.2 kg/m³ at outdoor air = 15 °C/85 % r.h.; ABL = 30 °C/53.7 % r.h., unless otherwise stated.

¹ Depending on unit equipment and installation height

² With fresh air = -12 °C / 90 % r.h.; extract air = 30 °C/53.7 % r.h.

³ With extract air = 30 °C/53.7 % r.h.

Functional description

Description

Dehumidification using outside air in winter: A large proportion of the sensible and latent heat is recovered from the return air, and is transferred to the supply air via the cross-counterflow heat exchanger and evaporator. If the heat output of the heat pump is not sufficient, the supply air will be further heated using the heating coil. Excess heat can be transferred to the optional pool water condenser for heating the pool water.

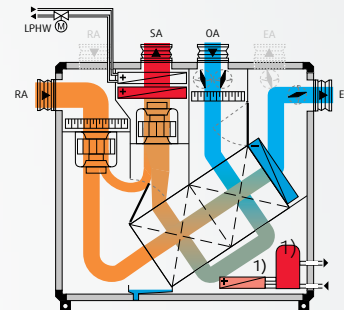

1) Option: pool water condenser

Recirculating air dehumidification:

The air is dehumidified in the evaporator of the heat pump; this process is intensified by the upstream connection of the heat exchanger. The already cooled and dried air is preheated in the heat exchanger by the swimming pool hall exhaust air. At the same time, the heat transfer on the other side of the heat exchanger causes the warm and humid swimming pool hall exhaust air to be cooled to near its dew point. The preheated, dehumidified air is then mixed with the proportion of untreated recirculated air, reheated at the condenser of the heat pump with the heat extracted during the dehumidification process and fed into the swimming hall as supply air. The heat pump is optimally designed with a dehumidification energy requirement of less than 0.25 kWh/kg. If required, the supply air is reheated by means of a hot-water heating coil.

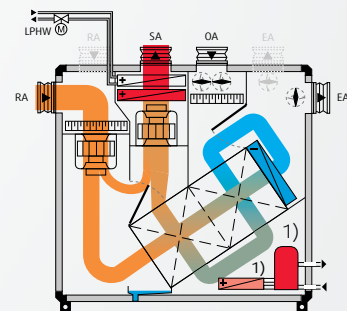

1) Option: pool water condenser

Domestic heat pump operation:

An existing domestic heat pump can be used for energy-efficient heating of the swimming pool hall air. The domestic heat pump is connected to the heating coil. Typically, the low flow temperatures of the domestic heat pump are not sufficient for heating the swimming pool hall air – the heating coil is therefore installed upstream of the air condenser of the integrated heat pump. The domestic heat pump can so then be operated with an optimal COP without a change in the low flow temperatures. In combination, the two systems heat the supply air to the desired temperature level.

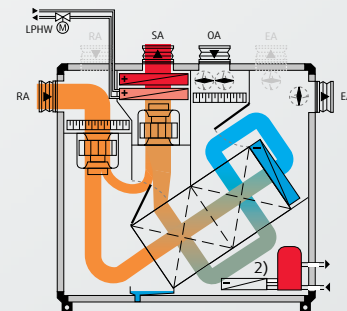

2) Option: domestic heat pump operation

All in one concept: Air handling unit with cross-counter-crossflow heat exchanger for private swimming pool halls

ThermoCond 23

- 📍 **Area of application:** Private wellness area, home spa, small swimming hall
- ⚠️ **Main functions:** Complete unit - includes all components for heating, dehumidification and ventilation of the swimming pool hall
- ⚙️ **Knowledge:** Units in the series 23 dehumidify and heat the swimming pool hall and they reduce a possible concentration of harmful substances in the air. The units are multifunctional compact systems with integrated control and regulation. ThermoCond 23 achieves a very high heat recovery rate based on a special heat exchanger.

Air volume flow:

1,510 – 4,725 m³/h



Additional details

Included performance parameters:

- Filtering the air in all operating modes
- Heating coil
- Individually controllable performance parameters
- Bypass damper
- Intensive quality inspection with factory test run

Additional options:

- Air tracks water control
- Remote maintenance
- And many more



ThermoCond 23



ThermoCond 23		23 12 01	23 18 01	23 26 01	23 36 01
Maximum volume flow ^{1,2}	m ³ /h	1,510	2,240	3,025	4,725
Heat recovery efficiency ³	%	92.6	92.7	94.3	93.1
Heat recovery efficiency according to EN 308	%	73	73	77	74
Dehumidification capacity acc. VDI 2089	kg/h	9.6	14.3	19.2	30.1
Total electrical input	kW	0.9	1.5	2.1	2.9
Power consumption	A	6.6	12.3	7.7	6.3
Operating voltage		1 / N / PE 230 V 50 Hz		3 / N / PE 400 V 50 Hz	
Sound power level					
Sound power level 1m from the unit	dB(A)	51	53	54	58
Connections					
LPHW connection	Inch	½	½	¾	¾
LPHW control valve connection	DN	10	10	15	15
Washing and condensate drains	DN	20	20	20	20
Dimensions					
Length	mm	2,580	3,060	3,700	3,700
Width	mm	570	730	730	1,050
Height	mm	1,210	1,530	1,850	1,850
Weight	kg	450	690	890	1,090
Control cabinet	mm	600 x 600 x 200			

All air volume flows are based on standard density 1.2 kg/m³ at outside air= 15 °C/85 % r.h.; extract air= 30 °C/53.7 % r.h., unless otherwise stated.

1 Upper volume flow limit for compliance with EU Regulation 1253/2014.

2 Depending on unit equipment and installation height

3 With outside air= -12°C / 90 % r.h.; extract air = 30 °C/53.7 % r.h.

Functional description

Description

Dehumidification using outside air in winter:

A large proportion of the sensible and latent heat is recovered from the return air and is transferred to the supply air in the heat exchanger. The cross-counter-flow-cross heat exchanger enables the recovery of over to 90 % of the heat contained in the return air. The ventilation heat losses that have to be covered by the heating coil are thus kept to a minimum.

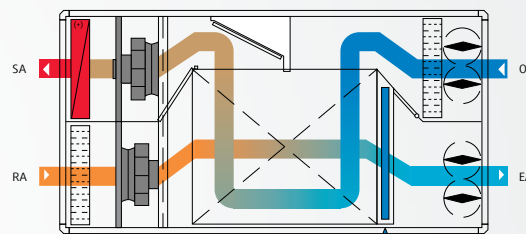

Recirculating air operation heating:

If no requirements are placed on temperature regulation or dehumidification when the unit is in standby mode, the system operates only in recirculating mode with reduced air volume flow. The air circulation in the swimming pool hall is guaranteed. If heating is required, the supply air is heated to meet the return air temperature required, using the heating coil.

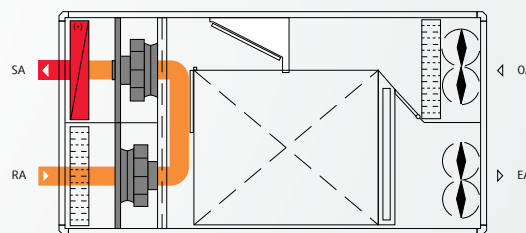

Dehumidification in the transitional period:

When outside air temperatures rise, the output of the heating coil can be reduced. The heat recovered can be regulated by means of the controllable bypass damper. A proportion of the outside air can by-pass the plate heat exchanger.

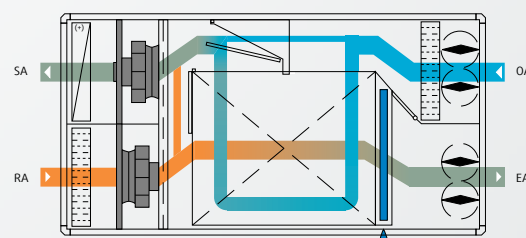

Summertime conditions:

In the case of rising outside air humidity, the recirculation air damper is closing as required. When the outside air humidity is high, the damper closes completely. The system works at 100 % outside air / exhaust air operation through the heat exchanger. Heat recovery is not required.

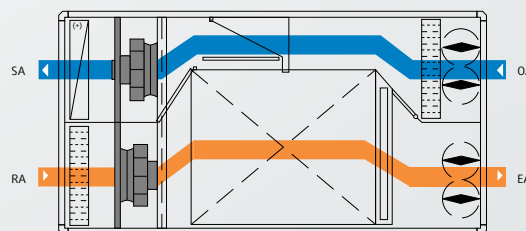





Area of Application: Aquaculture

- 48 **Aquaculture: Information**
- 52 **NX ThermoCond**
Air handling unit with counter-flow plate heat exchanger
- 56 **NX Adsolair**
Air handling unit with double plate heat exchanger and adiabatic evaporative cooling
- 62 **Drysolair**
Air dehumidification unit with cross counterflow plate heat exchanger and heat pump

Area of application: Aquaculture

Experience for 10 years:

We are the market and innovation leader in the field of indoor swimming pool ventilation. For 10 years we have been setting standards in the ventilation of land-based fish farms, so we know exactly what is important. Our systems ventilate, dehumidify and heat the rooms fully automatically, always at the most economical operating point.

Fish farms need to create precise and hygienic indoor climates for production halls, animals and staff. Humidity control is very important as bacteria can grow on damp surfaces.

Corrosion protection

In our units, the heat exchanger is made of polypropylene (PP) plastic. This material is highly resistant

to many types of acids, alkalis, salts and solvents. Our heat exchanger is highly resistant to corrosion and ageing. It is insensitive to oxidation, rusting and other typical corrosion processes.

Energy efficiency

It is important to choose energy-efficient equipment and optimise operating times to minimise energy consumption. Our solutions can reduce both operating costs and environmental impact.

Safety

On the other hand, a uniform movement of the air in the swimming pool hall ensures that the by-products released from the water during evaporation can be removed via the ventilation system. Due to the constant evaporation of water from the surface of

Case studies

Shrimps farm



Special features of this project:

The production halls of the shrimp farm require conditions comparable to a public swimming pool. Room temperature of approx. 30 °C, water temperature in the production pools 28 °C as well as a room humidity of approx. 60 %. Furthermore, the rearing pools are managed with salt-enriched water, equivalent to seawater. This requires increased corrosion protection in the facilities. Air conditioning is provided by two outdoor units installed on the roof.

Two ThermoCond units, each with 25,000 m³/h air volume.

the pool, the air in the indoor swimming pool must be dehumidified around the clock, even when the pool is not in use, in order to prevent damage to the building shell or other components.

Noise levels

Ventilation units can produce noise that can affect the well-being of the fish. Menerga’s units can be equipped with an attenuator and therefore have a low noise level. This is an important point to minimise stress for the fish.

Sizing

Ventilation units should be sized according to the size of the fish farm and the number of fish kept. Calculation of the required ventilation capacity is done in consultation with our sales engineers.

Air Handling by Menerga



Building fabric is protected:

High humidity in the factory hall is avoided by our units.



Protection of employees:

Filtering of the air so that chemical components are filtered out and the respiratory tract of the employees is not burdened.



Lower maintenance:

The use of our polypropylene heat exchanger, provides extra corrosion protection, contributing to a longer service life. Polypropylene has a high resistance to many types of acids, alkalis, salts and solvents.

Salmon farm



Norway Royal Salmon, Dåfjord

Air dehumidification for Aquaculture:

In Norway Royal Salmon’s production hall, we rely on a combination of 6 NX ThermoCond and 6 Drysolair units for ventilation and dehumidification. These state-of-the-art systems from Menerga not only ensure optimum air circulation, but also regulate the humidity in a controlled way. Thanks to the precise control, we create ideal conditions for the growth and well-being of the aquacultures.

All-in-one concept: Air handling unit with counterflow plate heat exchanger

NX ThermoCond Aquaculture

- Area of application:** Aquaculture
- Main functions:** Complete unit - includes all components for heating, dehumidification and ventilation of aquaculture, including all switching and control elements.
- Knowledge:** This complete unit contains all components for ideal heating, dehumidification and ventilation of the Aquaculture building. The units of the NX ThermoCond series achieve a very high passive energy efficiency, as the integrated control and regulation Determines the minimum proportion of outdoor air that is required for dehumidifying the indoor industry hall air. The integrated counterflow plate heat exchanger achieves the highest heat recovery rates with a real counterflow proportion of 80 %. Optionally, the units can be equipped with a fresh water heater for even more efficient use of the heat energy contained in the extract air.

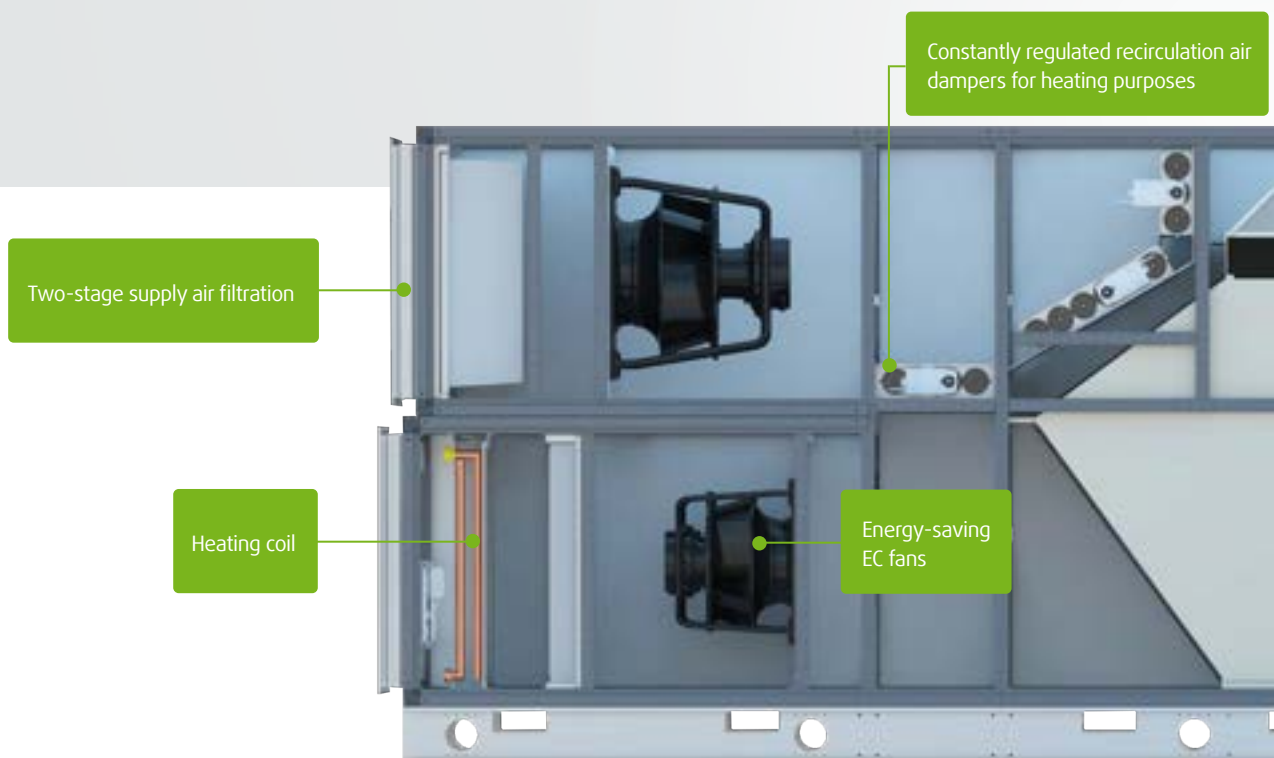

Air volume flow:
2,730 - 37,000 m³/h

Additional details

Included performance parameters:

- Corrosion-free counterflow plate heat exchanger made from polypropylene
- Heating coil
- Air filtration in all operating conditions, with filters in return, outside and supply air
- Constantly regulated recirculation air dampers for heating purposes
- Integrated freely programmable control and regulation unit
- Intensive quality inspection with factory test run
- Complete cleaning of the heat exchanger possible without dismantling

Additional options:

- Recuperator in shortened design
- Attenuator
- Outdoor installation
- Remote maintenance
- Fresh water heater
- Various BMS versions possible
- Your contact person is available for further possible options

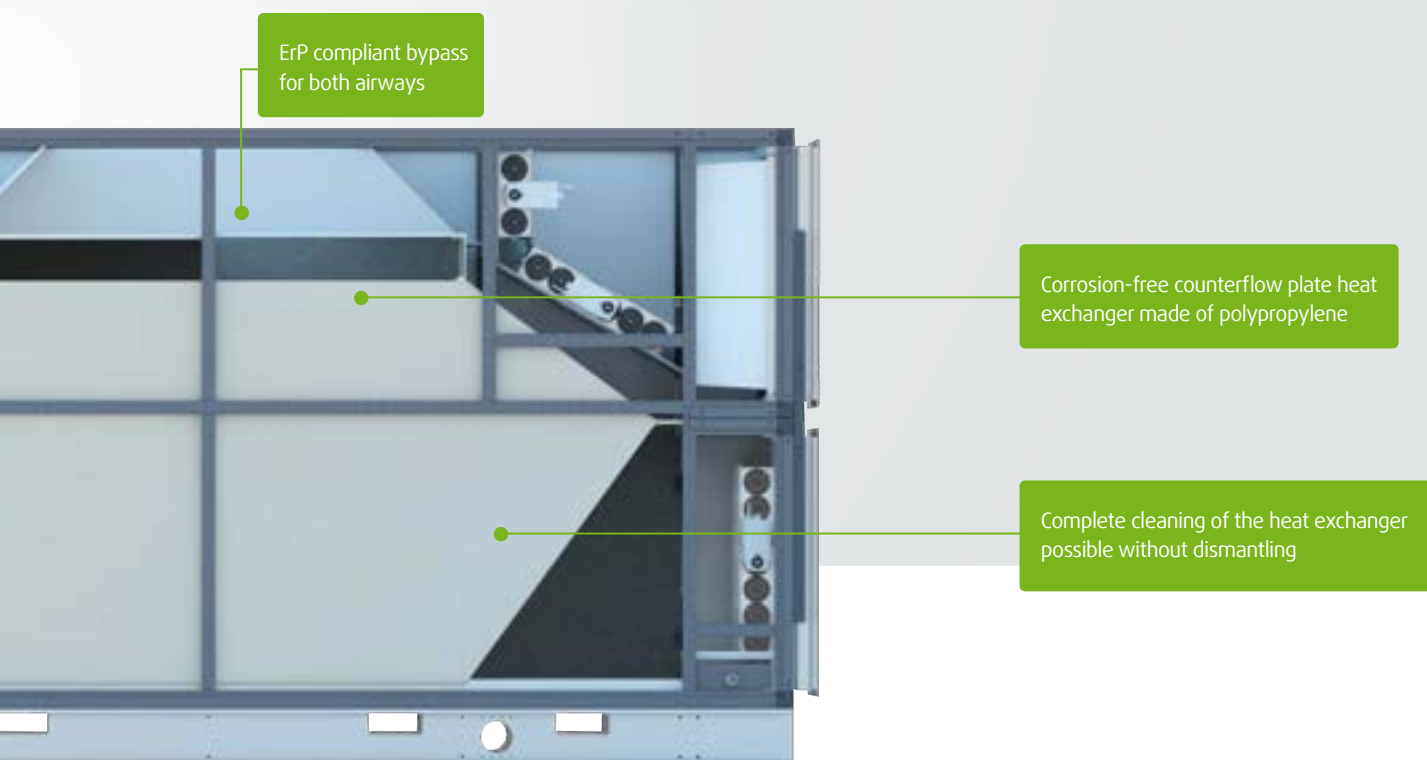

NX ThermoCond

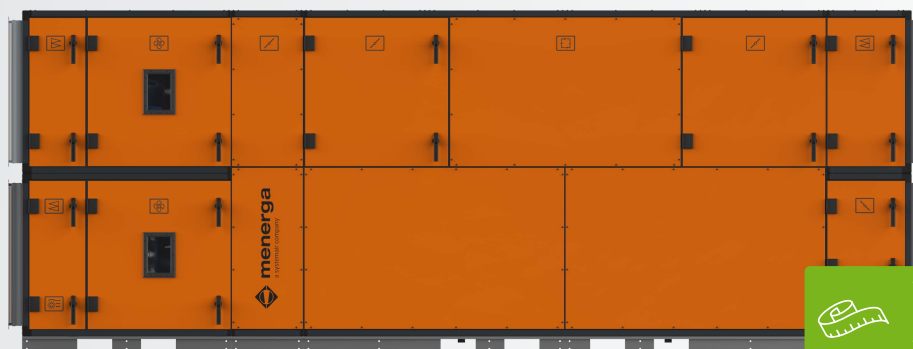

NX ThermoCond		10.10	15.10	10.15	15.15	20.15	25.15	30.15	30.20	35.20	45.20
Optimum flow rate ¹	m ³ /h	2,730	4,000	4,000	5,840	7,690	9,540	11,380	14,980	17,410	22,270
Volume flow ErP 2018 ^{2,4}	m ³ /h	3,300	4,800	4,850	7,000	9,400	11,850	14,000	18,800	22,200	27,500
Heat recovery efficiency ³	%	87.1	87.5	89.8	90.2	90.4	90.5	90.6	92.7	92.8	92.9
Heat recovery efficiency acc. EN 308	%	75.0	76.0	78.0	78.0	78.0	78.0	79.0	81.0	81.0	81.0
Dehumidification capacity V _{opt}	kg/h	17.3	25.4	25.4	37.1	48.8	60.5	72.2	95.0	110.4	141.2
Dehumidification capacity ErP 2018 ⁴	kg/h	21.0	30.5	30.8	44.4	59.6	75.2	88.8	119.3	140.8	174.4
Max. current consumption ¹	A	11.0	11.0	11.0	14.0	14.0	15.2	20.4	23.0	35.8	35.6
Electrical input power ¹	kW	1.9	2.6	2.6	3.6	4.9	5.7	7.7	10.6	13.6	18.0
Operating voltage		3/N/PE 400V 50Hz									

Connections

	Inch	1 ¼	1 ¼	1 ¼	1 ½	1 ½	1 ½	1 ½	2	2 ½	2 ½
LPHW connection	Inch	1 ¼	1 ¼	1 ¼	1 ½	1 ½	1 ½	1 ½	2	2 ½	2 ½
LPHW control valve connection	DN	15	15	15	20	25	25	25	32	32	32
Condensate drainage	DN	40	40	40	40	40	40	40	40	40	40
Floor drain	DN	20	20	20	20	20	20	20	20	20	20
Clean water heater ⁵	DN	15	15	15	15	15	15	15	15	15	15

Sound power level

	dB(A)	57	56	56	57	59	57	61	62	63	69
Acoustic pressure 1 m from unit ¹	dB(A)	57	56	56	57	59	57	61	62	63	69

Dimensions (with standard configuration)

	mm	5,332	5,332	6,032	6,182	6,182	6,432	6,432	6,782	7,032	7,032
Length	mm	5,332	5,332	6,032	6,182	6,182	6,432	6,432	6,782	7,032	7,032
Width	mm	782	1,082	782	1,082	1,382	1,682	1,982	1,982	2,282	2,882
Height	mm	1,842	1,842	2,442	2,442	2,442	2,442	2,442	3,042	3,042	3,042
Weight	kg	1,128	1,364	1,490	1,857	2,180	2,631	2,924	3,622	4,209	5,135

Largest transport unit

	mm	3,000	3,000	3,600	3,600	3,600	3,600	3,600	4,100	4,100	4,100
Length	mm	3,000	3,000	3,600	3,600	3,600	3,600	3,600	4,100	4,100	4,100
Width	mm	782	1,082	782	1,082	1,382	1,682	1,982	1,982	2,282	1,441
Height	mm	1,842	1,842	2,442	2,442	2,442	2,442	2,442	3,042	3,042	3,042
Weight	kg	617	766	902	1,109	1,327	1,614	1,765	2,315	2,627	3,276
Weight of transport unit	kg	106	129	124	153	182	211	240	279	312	378
Weight of transport unit	kg	79	92	106	120	134	148	162	197	212	253
Weight of transport unit	kg	405	469	464	595	671	806	919	1,028	1,270	1,481

¹ At air velocity 1.8 m/s

² Depending on unit equipment and installation height

³ At OA = -12 °C / 90 % r.h.; EA = 30 °C/53.7 % r.h.

⁴ Upper volume flow rate limit for compliance with EU Regulation 1253/2014

⁵ Optional equipment

All air volume flows are based on standard density 1.2 kg/m³ at OA = 15 °C/85 % r.h.; EA = 30 °C/53.7 % r.h., unless otherwise stated.

Functional description

Description

Standby mode:

No requirements for temperature and dehumidification, unit operates in pure recirculation mode. The aim is air circulation with reduced fan power.

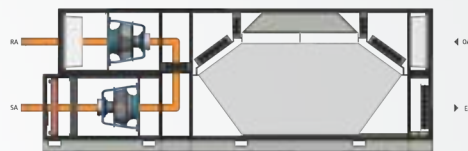

Recirculation mode Heating:

Heating as required via heating coil. The fresh air and exhaust air dampers are closed.

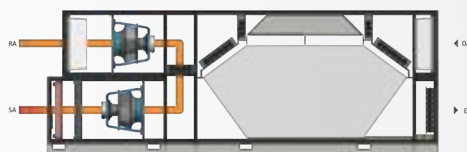

Dehumidification on the unit with counterflow heat exchanger:

Dehumidification of the indoor swimming pool air through demand-dependent mixing of outside air (minimum necessary outside air quantity during bathing operation according to VDI 2089 or local regulations) to the recirculation air volume flow. If necessary: Reheating of the supply air.

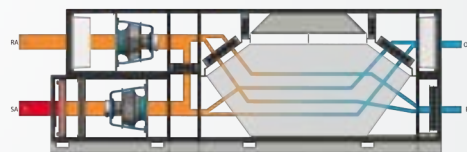

Fresh air / exhaust air mode:

As the outdoor air humidity rises, the recirculation damper is closed as required. When the outdoor humidity is high, the damper closes completely and the unit operates in outdoor air exhaust mode.

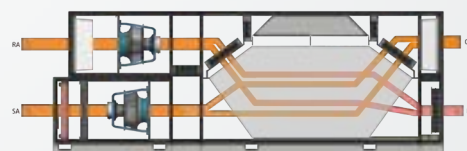

Defrost mode:

Recuperative heat exchangers tend to ice up at low outdoor air temperatures. This is prevented by opening the extract air/extract air bypass as required. The fresh air supply is not interrupted in the process.

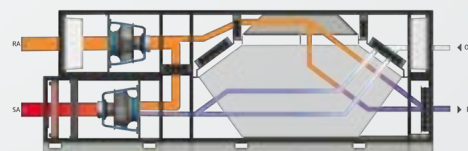

Heat exchanger bypass:

The proportion of air routed via the heat exchanger and the bypass can be regulated up to free cooling.



All-in-one concept: Air handling unit with double plate heat exchanger and adiabatic evaporative cooling

NX Adsolair

- Area of application:** Surrounding industrial areas of the aquaculture, e.g. production halls, storage rooms, cold storage rooms and offices
- Main functions:** Complete unit ready for connection, contains all components for low energy ventilation, including all switching and control elements.
- Knowledge:** Requirements with high thermal loads can be ideally met with the different cooling options of the units in series Adsolair. The unit uses adiabatic evaporative cooling and achieves to cool up to 12 K (at OA = 34 °C / 40 % r.h.) with water. At series 58 the total cooling capacity is further enhanced with an integrated compression refrigeration system.

Air volume flow:
2,200 – 40,800 m³/h

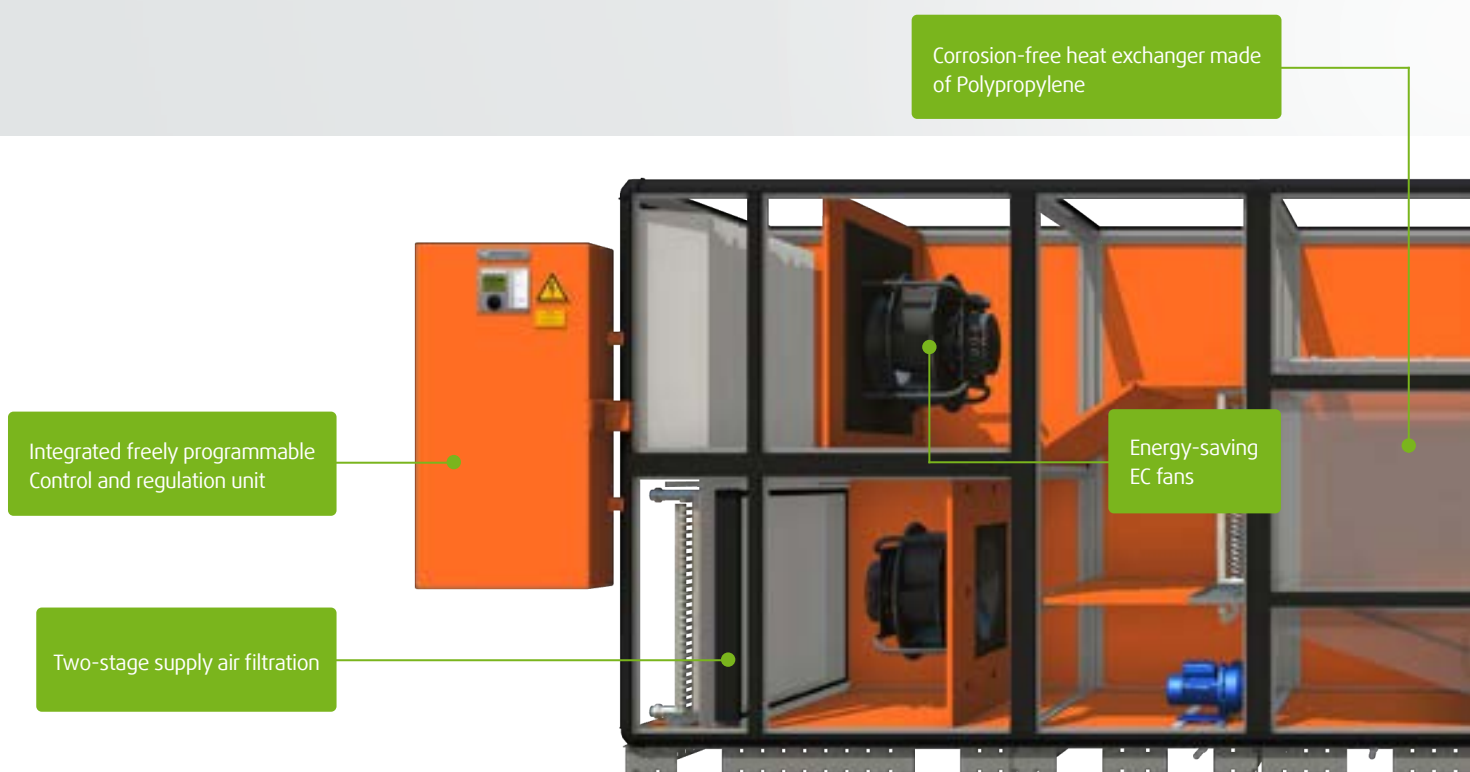

Additional details

Included performance parameters:

- Filtering of the air in every operating mode
- Corrosion-free heat exchanger made of Polypropylene
- Pump hot water heating coil
- Thermal bridge factor TB1
- Individually adjustable performance parameters
- Intensive quality testing with factory test run

Additional options:

- Automatic heat exchanger cleaning system
- Pump cold water cooling coil (Series 56)
- Pressure reversal
- Attenuator
- Reversible refrigeration system (Series 58)
- Outdoor installation
- Hot water extraction to use the waste heat for heating purposes (Series 58)
- Increase in cooling capacity
- Remote maintenance
- Larger air volumes on request
- And many more

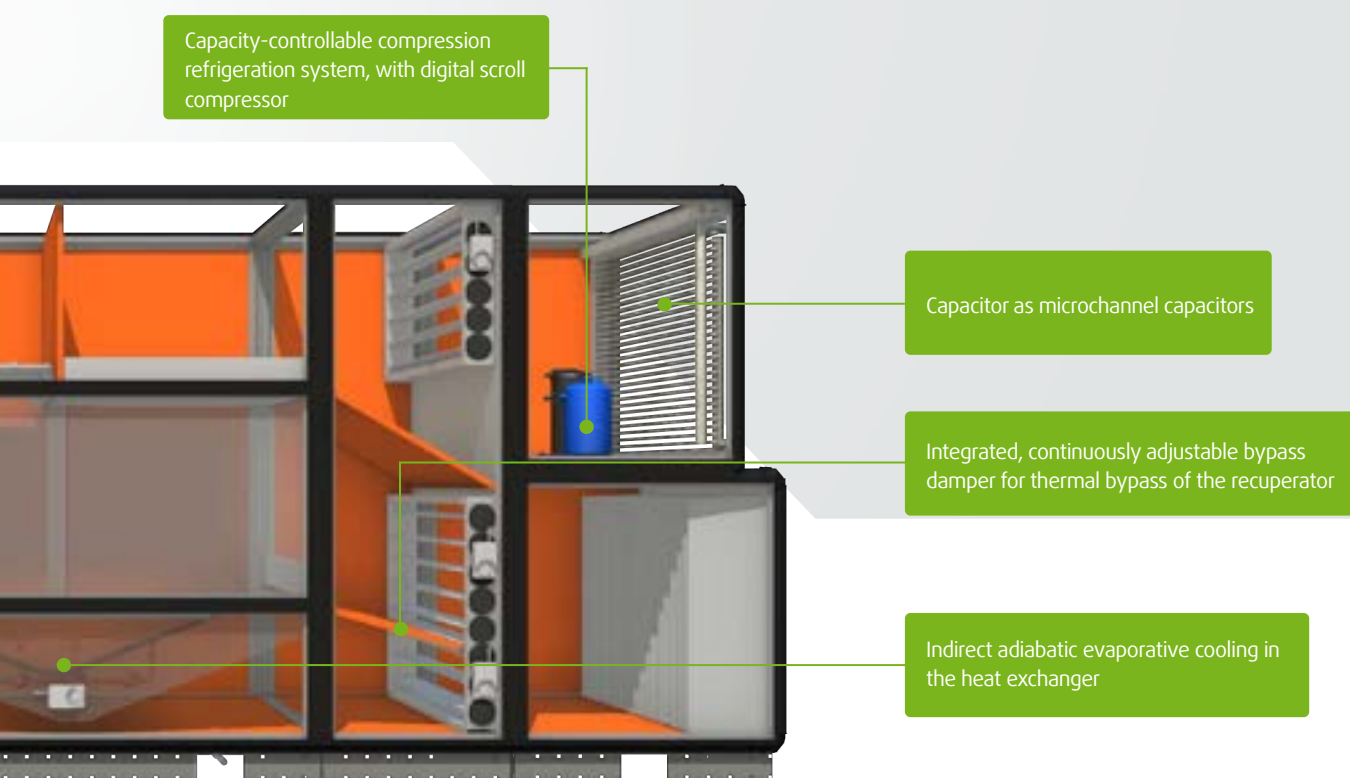

NX Adsolair 56

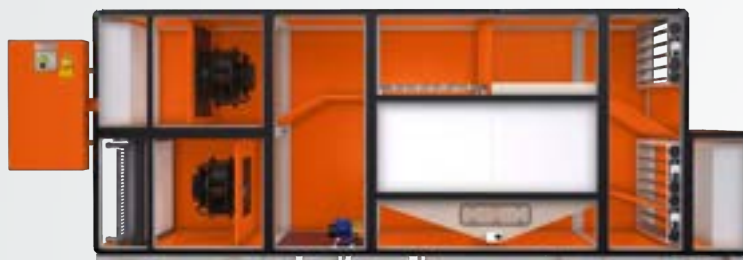

NX Adsolair 56		56 03 01	56 05 01	56 06 01	56 10 01	56 13 01	56 16 01	56 19 01	56 25 01	56 32 01	56 36 01
Optimum volume flow	m ³ /h	2,200	3,200	3,800	5,500	7,300	9,100	10,900	12,800	16,800	19,900
Max. Volume flow	m ³ /h	2,200	3,200	4,200	6,000	7,900	9,900	11,800	15,000	19,800	22,800
Energy efficiency according to EN13053:2012	%	71	71	73	73	73	73	73	77	74	74
Heat recovery efficiency according to EN 308	%	72.3	72.3	75.5	75.8	75.7	75.8	75.7	80	76.8	76.6
Power consumption	A	9.1	9.1	9.1	10.7	17.4	17.4	18.8	33.6	33.6	39.7
Cooling capacity adiabatic	kW	7.9	11.7	13.6	19.8	26.6	32.7	39.1	48.3	61.0	72.1
Electr. input power ¹	kW	1.76	2.3	2.76	3.82	4.95	5.92	7.97	10.26	13.46	16.2
Operating voltage ¹		3 / N / PE 400 V 50 Hz									

Connections

LPHW connection	DN	32	32	32	32	40	40	40	50	50	65
LPHW control valve connection	DN	15	15	15	15	15	15	20	25	25	25
Condensate	DN	40	40	40	40	40	40	40	40	40	40
Floor drains	DN	40	40	40	40	40	40	40	40	40	40

Sound power level

Sound power 1m from the unit	dB(A)	40	42	43	47	42	47	55	49	53	57
------------------------------	-------	----	----	----	----	----	----	----	----	----	----

Dimensions

Length	mm	4,510	4,670	5,790	5,790	5,950	5,950	5,950	6,590	7,390	7,390
Width	mm	790	1,110	790	1,100	1,430	1,750	2,070	2,070	2,070	2,390
Height	mm	1,700	1,700	2,340	2,340	2,340	2,340	2,340	2,980	3,620	3,620
Weight	kg	1,120	1,370	1,570	1,880	2,230	2,560	2,840	3,840	4,700	5,280

Largest transport unit

Length	mm	2,670	2,670	3,790	3,790	3,790	3,790	3,790	4,430	5,230	5,230
Width	mm	790	1,110	790	1,110	1,430	1,750	2,070	2,070	2,070	2,390
Height	mm	1,700	1,700	2,340	2,340	2,340	2,340	2,340	2,980	3,620	3,620
Weight	kg	620	770	970	1,150	1,340	1,540	1,720	2,440	3,150	3,550

Specifications of technical data relate to the optimum flow rate and return air condition 22 °C / 40 % r.h., outside air condition -12 °C / 90 % r.h. and standard density (1.204 kg/m³), unless otherwise specified.

¹ Dependent on configuration of measurement and control system/unit

Functional description

Description

Wintertime conditions: In case of low outside temperatures the system operates in full heat recovery mode. The standard heating coil (LPHW) compensates for ventilation and transmission heat losses of the building as required.

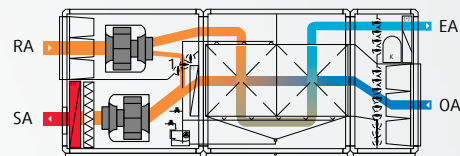

Defrosting circuit: All recuperative heat exchangers tend to ice over in the exhaust air section with low outside temperatures. In defrost operation, the OA-SA bypass opens, reducing the outside air flow rate going through the recuperator. The heat contained in the return air melts any ice in the heat exchanger, while the airflow rate routed through the recuperator is regulated as required.

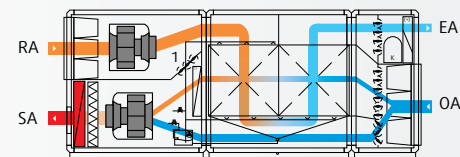

Transitional period: As the outside air temperature rises, the heat recovery demand is reduced. The OA/SA bypass damper, which runs the entire depth of the unit, is continuously regulated in order to achieve the desired supply airtemperature.

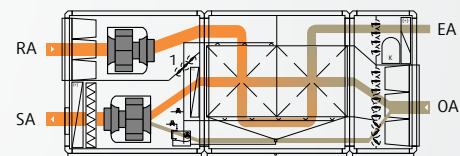

Free cooling: If the outside temperature continue to rises, the heat recovery is bypassed. The structural design of the OA/SA bypass ensures that the pressure losses within the unit are low and that the power consumption of both fans in bypass mode is also low.

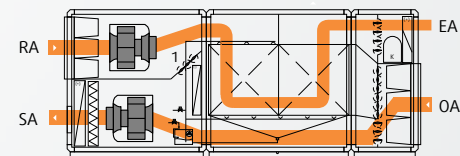

Summertime conditions: If the outside temperature rises above the return temperature, the highly efficient heat exchanger is used as a „cooling recovery system“. The warm outside air is cooled by the return air.

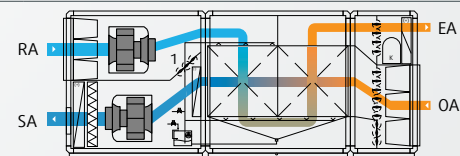

Indirect adiabatic evaporative cooling: The Menerga Adsolair principle uses the advantages of indirect adiabatic evaporative cooling without the disadvantages of supply air humidification. A major component of the Adsolair principle is the double plate heat exchanger, in which the return air is adiabatically cooled. In return, the outside air is cooled by the humid, cold exhaust air, without being humidified. The high efficiency rate lies in the fact that both processes (adiabatic evaporative cooling of the return air + cooling of the outside air) take place simultaneously in the heat exchanger. The high degree of temperature efficiency of the double plate heat exchanger allows significant cooling of the OA-SA by over 12 K (at OA = 34 °C / 40 % r.h.). If required, the compressor refrigeration system will switch on and cool the supply air even further.

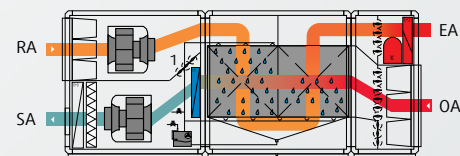

NX Adsolair 58

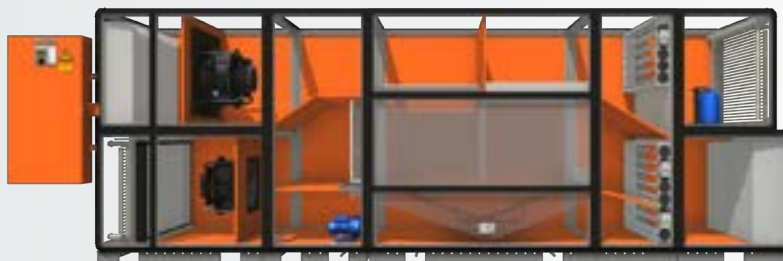

NX Adsolair 58		58 03 01	58 05 01	58 06 01	58 10 01	58 13 01	58 16 01	58 19 01	58 25 01	58 32 01	58 36 01
Optimum volume flow	m ³ /h	2,200	3,200	3,800	5,400	7,300	9,100	10,900	12,700	16,700	19,900
Max. Volume flow	m ³ /h	2,200	3,200	4,200	5,950	7,900	9,950	11,800	14,800	19,500	22,500
Total cooling capacity ¹	kW	16.5	23.30	23.6	35	44.9	57.2	69.8	83.7	106.5	120.2
Total cooling capacity number ^{1,2}	EER	6.9	8.3	10.3	10.3	11.5	10.0	10.0	10.7	11.0	12.8
Energy efficiency according to EN 13053:2012	%	71	71	73	74	73	73	73	77	74	74
Heat recovery efficiency according to EN 308	%	72.3	72.3	75.5	76	75.7	75.8	75.7	80.1	76.9	76.6
Power consumption ³	A	16.1	17.3	16.4	21.2	29.4	34.6	39.1	55.9	66.2	71.8
Cooling capacity adiabatic	kW	7.9	11.7	13.6	19.4	26.2	32.7	39.1	47.9	60.6	72.1
Electr. input power ³	kW	4.0	4.9	4.9	7.0	8.7	11.4	14.7	17.8	23.0	25.0
Operating voltage		3/N/PE 400V 50Hz									

Connections

PWW connection	DN	32	32	32	32	40	40	40	50	50	65
PWW control valve connection	DN	15	15	15	15	15	15	20	25	25	25
Condensate drain	DN	40	40	40	40	40	40	40	40	40	40
Floor drain	DN	40	40	40	40	40	40	40	40	40	40

Sound power level

Sound power level 1m from the unit	dB(A)	41	42	43	47	42	47	54	49	54	57
------------------------------------	-------	----	----	----	----	----	----	----	----	----	----

Dimensions

Length	mm	4,830	4,990	6,110	6,110	6,270	6,270	6,270	6,910	7,710	7,710
Width	mm	790	1,110	790	1,100	1,430	1,750	2,070	2,070	2,070	2,390
Height	mm	1,700	1,700	2,340	2,340	2,340	2,340	2,340	2,980	3,620	3,620
Weight	kg	1,320	1,620	1,800	2,130	2,590	2,830	3,340	4,440	5,400	6,400

Largest transport unit

Length	mm	2,670	2,670	3,790	3,790	3,790	3,790	3,790	4,430	5,230	5,230
Width	mm	790	1,110	790	1,110	1,430	1,750	2,070	2,070	2,070	2,390
Height	mm	1,700	1,700	2,340	2,340	2,340	2,340	2,340	2,980	3,620	3,620
Weight	kg	640	790	1,000	1,200	1,400	1,620	1,810	2,580	3,400	3,800

Specification of technical data refers to optimum volume flow and extract air condition 22 °C / 40 % r.h., fresh air condition -12 °C / 90 % r.h. and standard density (1.204 kg/m³), unless otherwise stated.

² Incl. evaporative cooling capacity taking into account power consumption for adiabatic pump(s)

³ Dependent on configuration of measurement and control system/unit

¹ With extract air 26 °C; 55 % r.h. and outside air 32 °C; 40 % r.h.



SwissShrimp AG - Sustainable shrimp farm, Rheinfelden

All in one concept: Air dehumidification unit with cross counterflow plate heat exchanger and heat pump

Drysolair 11

- Area of application:** Food production, Aquaculture
- Main functions:** Complete unit ready for connection, includes all components for air dehumidification for all drying applications with cross-flow plate heat exchanger and heat pump.
- Knowledge:** Units in the Drysolair 11 series were developed especially for discharging high levels of internal moisture to the atmosphere. Through the pre-cooling in the recuperator of the air to be dried, the unit works with considerably lower compressor performance than a simple heat pump system and creates a consistently good climate in ice rinks, the drying of buildings or industrial drying processes. The combination of first-class components with precise control and regulation guarantees economical operation at all times and adjusts the temperature and humidity as required.

Air volume flow:
1,000 – 6,000 m³/h

Integrated control and regulation,
compatible with all common BMS systems

Low connected load due to
Upstream connection of a recuperator

Corrosion-free cross counterflow plate
heat exchanger made from polypropylene



Additional details

Included performance parameters:

- Specific power consumption of less than 500 Wh/kg dehumidification capacity
- Air filtration
- Corrosion-free heat exchanger made of polypropylene
- Individually adjustable performance parameters
- Complete unit ready for connection, contains all components for industrial air-conditioning, including all switching and control elements.
- Intensive quality testing with factory test run

Additional options:

- Room humidity control
- Hot water condenser
- Remote maintenance
- And many more



Energy-saving
EC fans

Compact
design

All in one concept: Air dehumidification unit with cross counterflow plate heat exchanger and heat pump

Drysolair 11

Drysolair 11		11 10 01	11 15 01	11 40 01	11 60 01
Optimum flow rate	m ³ /h	1,000	1,500	4,000	6,000
Max. current consumption ²	A	9.1	11.9	18.5	24.2
Operating voltage		3 / N / PE 400 V 50 Hz			
External pressure loss					
Supply and return air channel	Pa	300	300	300	300
Connections					
Condensate drainage	DN	25	25	25	25
Sound power level					
Sound power level 1m from the unit ⁵	dB(A)	50	47	50	56
Air inlet 20 °C / 70% r.F. ¹					
Dehumidification capacity ⁴	kg/h	4.5	6.8	17.6	21.6
Heating capacity	kW	4.7	7.5	18.3	23.4
Specific dehumidification energy requirement	Wh/kg	382	443	386	455
Total power rating	kW	1.7	3.0	6.8	9.8
Compressor input power	kW	1.2	2.3	5.5	7.1
Fan motor input power ³	kW	0.5	0.7	1.3	2.7
SFP - Category		4	4	3	4
Air inlet 10° C / 85% r.h. ¹					
Dehumidification capacity ⁴	kg/h	2.7	4.4	10.6	12.9
Heating capacity	kW	2.8	4.4	10.3	13.4
Specific dehumidification energy requirement	Wh/kg	411	407	370	485
Total power rating	kW	1.1	1.8	3.9	6.3
Compressor input power	kW	0.6	1.1	2.7	3.6
Fan motor input power ³	kW	0.5	0.7	1.2	2.7
SFP - Category		4	4	3	4
Dimensions					
Length	mm	730	730	1,050	1,050
Width	mm	730	730	1,050	1,050
Height	mm	2,245	2,245	2,725	2,725
Weight	kg	450	450	660	680
Largest transport unit					
Length	mm	730	730	1,050	1,050
Width	mm	730	730	1,050	1,050
Height	mm	1,755	1,755	2,155	2,155
Weight	kg	300	300	500	500

¹ Other configurations on request

² Dependent on configuration of measurement and control system/unit

³ With medium filter contamination

⁴ Observe reduction of dehumidification performance due to defrosting intervals

⁵ At 250 Hz centre frequency

All technical data relate to optimum flow rate through heat recovery system and the air inlet conditions specified above and at standard density (1.204 kg/m³).

Functional description

In recirculation mode humid air is dehumidified in two stages and supplied into the room as dry supply air. The return air is pre-cooled and dehumidified in the plate heat exchanger.

Climate solution from Menerga

The dehumidification to the desired supply air humidity level takes place by means of cooling the air to below its dew point in the evaporator of the heat pump. The air that has been dried in this manner is then warmed back up again in the condenser of the heat pump using its own heat, which was removed during cooling, and is brought to the required condition. The pre-cooling in the plate heat exchanger of the air to be dried means that the air dehumidification unit operates with a considerably lower compressor performance and hence a significantly lower energy consumption than a simple heat pump solution. The integrated bypass allows fast and precise control and adjustment to the condition of the return air. The cooling capacity is thus continuously adapted to the respective requirements.

Specific dehumidification energy requirement

Drysolair achieves a specific dehumidification energy requirement of far less than 500 Wh/kg. With one kilowatt hour of electrical energy, it is therefore possible to remove more than 2 kg of humidity from the recirculation air. In contrast, classical solutions without integrated heat recovery systems reach peak values in excess of 1,000 Wh/kg.

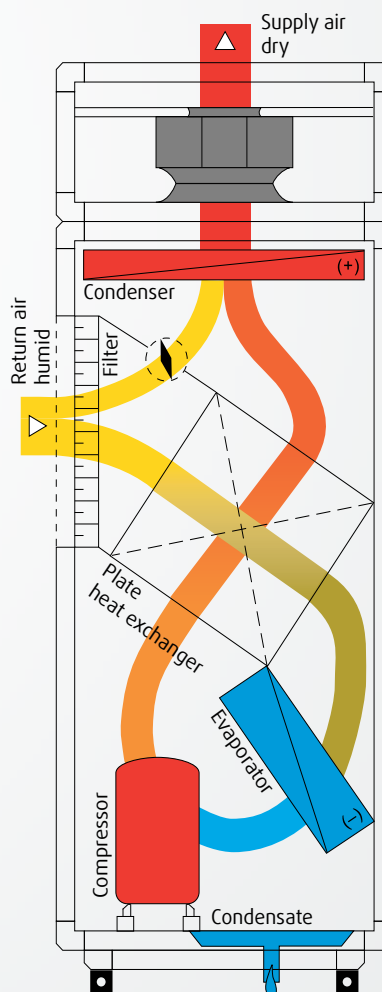

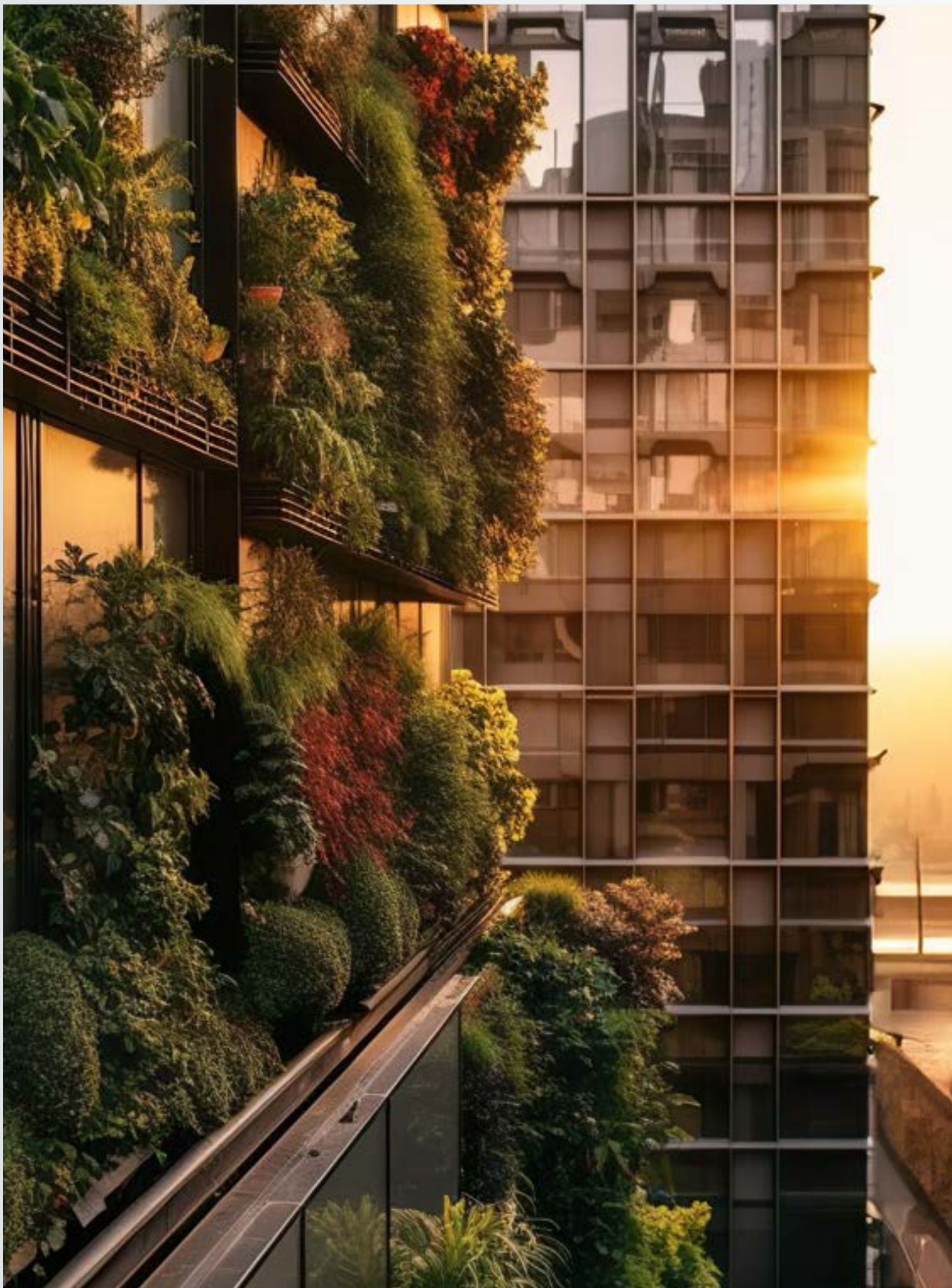

Area of Application: Net-Zero Energy Buildings (NZEB)

- 66 **Net-zero energy buildings:
Information**
- 72 **Trisolair**
Air handling unit with cross-
counterflow-cross heat exchan-
ger
- 78 **NX Adconair**
Air handling unit with counter-
flow plate heat exchanger
- 88 **NX Adsolair**
Air handling unit with double
plate heat exchanger and adia-
batic evaporative cooling
- 96 **NX Resolair**
Air handling unit with highly
efficient regenerative heat
storage packages

Innovative ventilation solution pioneers net-zero energy buildings

The concept of net zero energy buildings has gained popularity as a sign of progress in sustainability and energy efficiency. These buildings represent a rethinking of architecture and engineering, as they generate as much energy as they consume. Menerga leads this movement with a pioneering ventilation solution for net-zero energy buildings. Through the clever integration of cutting-edge technology and a deep-rooted commitment to the environment, Menerga is redefining how net-zero energy building structures are ventilated and their interiors optimised.



Office

Excess heat is often generated in offices due to the presence of a large number of people and the use of technical equipment, such as computers, copiers, and lighting. The role of air conditioning in offices is primarily focused on cooling and dehumidification during the summer months, as well as ensuring a constant air exchange. It is important to maintain a constant room temperature and humidity level.



Education

It is particularly important in settings such as schools, universities, and kindergartens to ensure a continuous supply of fresh air through ventilation and air conditioning in accordance with demand. If feasible, this should be based on regulation controlled by CO₂. As the concentration of CO₂ increases in the air, people are more likely to experience fatigue, headaches, and lack of concentration. Demand-controlled air conditioning significantly reduces energy costs since the rooms are used only for limited periods during the day.

Sustainable air handling for net-zero energy buildings (NZEBs):

Im globalen Streben nach nachhaltigen und energieeffizienten Gebäuden gewinnen Netto-Null-Energie-Gebäude (NZEB) zunehmend an Bedeutung, da sie Energieproduktion und -verbrauch in Einklang bringen. In diesem progressiven Umfeld nimmt Menerga eine Spitzenposition ein und bietet hochmoderne Lösungen im Bereich der Klima- und Lüftungstechnik an, die sich mit den strengen Vorschriften und Anforderungen für NZEB decken.

Menerga's innovative solutions in focus:

The current regulations affecting NZEB in the field of air conditioning and ventilation play a crucial role in ensuring the smooth operation and optimal performance of these pioneering structures. Menerga recognises the importance of these regulations and

uses its commitment to environmentally friendly technologies and innovative approaches to meet the requirements of modern legislation.

A key element of the NZEB regulations is the need for efficient climate control and ventilation, which aims to minimise energy consumption while creating a comfortable and healthy indoor environment for occupants. Menerga has responded by developing bespoke climate control and ventilation solutions specifically designed to meet the unique requirements of NZEB.

In summary:

Our solutions are designed to maximise energy efficiency and promote the use of renewable energy sources, while providing maximum comfort and excellent indoor air quality.



Cultural institutions

Optimal regulation of temperature and humidity on the exhibit surfaces and within the room itself prevents the destruction or premature aging of the exhibits. A good air conditioning system also automatically adjusts to changes in the number of visitors to maintain the desired air quality at all times.



Many more

If you're looking for reliable, efficient and sustainable solutions for your project, you've come to the right place. Contact us today to find out more about our products and services and how we can help you transform your building into an energy efficient and environmentally friendly showpiece. Together we can build a sustainable future.

Unit overview

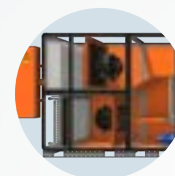

NZEB

NX Adconair

NX Adsolair

Office	A healthy indoor climate with a continuous supply of fresh air increases employee productivity.	+++	++
Museum	Different exhibits place the most varied demands on the necessary air conditions.	+++	++
Theatre	High air volumes, high comfort, but without noticing it. Here, the ventilation technology is often completely hidden.	+++	+++
Laboratory	Laboratories not only require the highest precision in supply air quality, but often also special protection for the unit.	+	+++
Nursing homes	The feel-good climate must be ensured all year round for residents, guests and staff alike.	+++	++
Art galleries	Adherence to narrow tolerances places the highest demands on the equipment.	+++	++
Education	Central ventilation systems provide hygienic air exchange all year round without disturbing equipment in the classroom.	+++	++
Passive House	Building with the very highest energy efficiency as a goal - with certified units up to 15,000 m ³ /h.	+++	
Commercial kitchens	The greasy exhaust air requires special protection of the units. Exclusively with us, there is a matching self-cleaning system for heat recovery.	+	+++
Archives	Precision climates with tight tolerances make high-performance measurement and control system technology indispensable.	+	++
Ventilation with polluted exhaust air	Whether it's a laboratory or an industrial hall, high-tech equipment such as the self-cleaning function or plastic lining are in demand.	+	+++



NX Resolair



Trisolair

NX Resolair	Trisolair
++	+ +
+++	+
+	+ +
+	+ + +
++	++
+++	+++
+++	
+++	+++
+++	+++

- + Good
- ++ Excellent
- +++ Best in Class

Products at a glance

To help you understand the application range of our products at a glance, we have created an evaluation table to help you make the right choice for your individual requirements.

This evaluation table is designed to help you select the right ventilation solution for your specific requirements. If you have any questions or are unsure, our experts will be happy to help you with your decision.

Menerga rating system

Good: This rating indicates that our air handling units perform solidly in this application area. They meet basic requirements and are a reliable choice for normal applications.

Excellent: Air handling units with this rating exceed the standards and offer above-average performance in this area. They are ideal for situations where improved efficiency and performance is required.

Best in Class: Our air handling units with this rating represent the ultimate in this application area. They offer outstanding performance, innovative technology and maximum efficiency. If you are looking for the best of the best, these are the solutions to meet your needs.

All in one concept: Air handling unit with cross-counterflow-cross heat exchanger

Trisolair

- Application area:** Office, museum, theatre, nursing homes, art galleries, educations, technical rooms, ancillary rooms, changing rooms
- Main functions:** Complete unit ready for connection, includes all components for low energy ventilation, including all switching and control elements.
- Knowledge:** Trisolair 52 and 59 series combine the highest heat recovery efficiency, low pressure drops and compact design. Ideal application areas are refurbishments at low to medium air volumes. A compressor refrigeration system integrated into the 59 series increases the cooling capacity of the overall system at high temperatures and additionally allows dehumidification of the outside air.

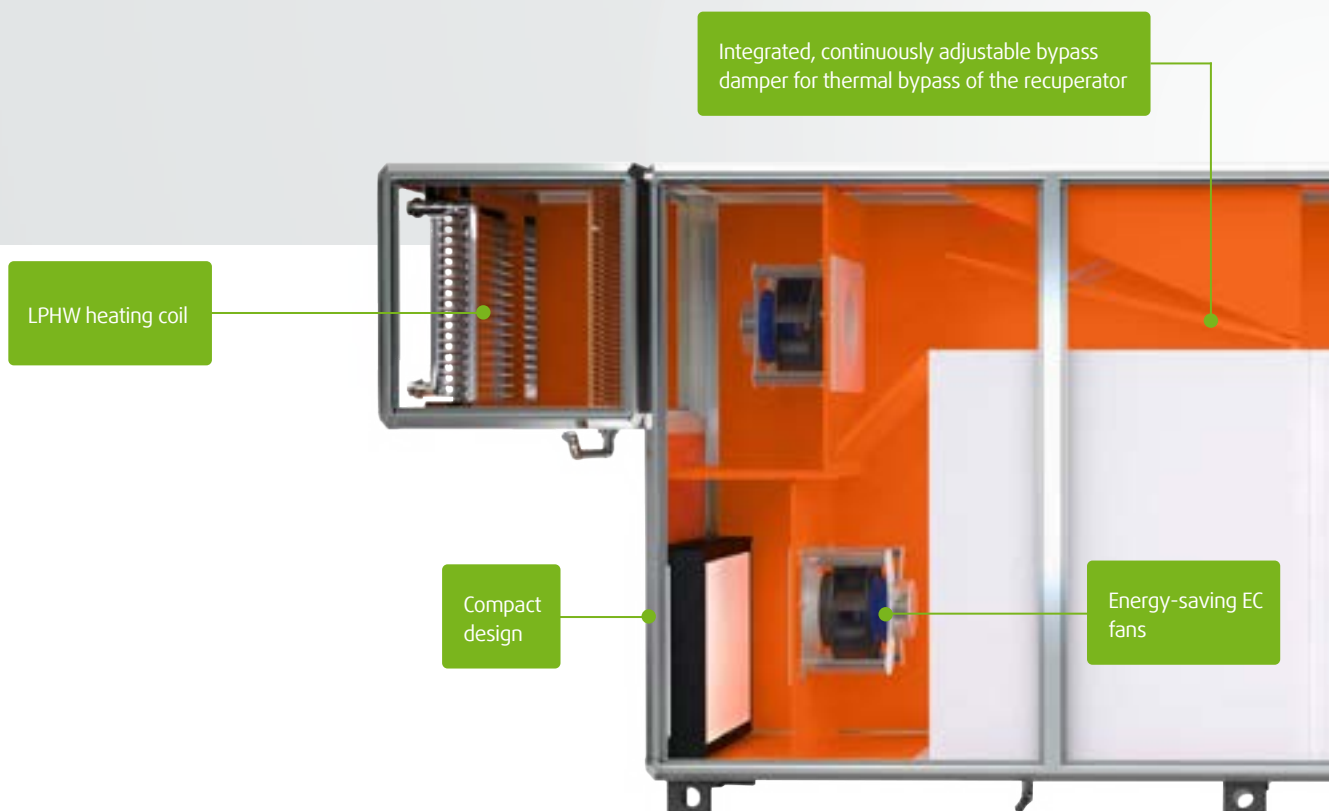

Air volume flow:
1,180 – 4,900 m³/h

Additional details

Included performance parameters:

- Filtering the air in all operating modes
- Corrosion-free heat exchanger made from polypropylene
- Heating coil
- Bypass damper
- Individually controllable performance parameters
- Intensive quality inspection with factory test run

Additional options:

- Recirculation air dampers for heating purposes
- Cooling coil
- Remote maintenance
- And many more



Trisolair 52



Trisolair 52		521201	521801	522601	523601
Optimum flow rate	m ³ /h	1,180	1,770	2,550	3,540
Max. volume flow rate ^{1,2}	m ³ /h	1,550	2,450	3,140	4,900
Heat recovery efficiency ³	%	81.6	81.8	84.7	83.3
Heat recovery efficiency according to EN 308	%	77	76	79	78
Power consumption	A	6.6	12.3	7.7	6.3
Electr. input power	kW	0.7	1.1	1.6	1.9
Operating voltage		1 / N / PE 230 V 50 Hz		3 / N / PE 400 V 50 Hz	
Sound power level					
Sound pressure 1 m from the unit	dB(A)	54	51	53	53
Connections					
LPHW connections	DN	32	32	32	32
LPHW control valve	DN	10	10	10	10
Floor and condensate drains	DN	20	20	20	20
Dimensions					
Length	mm	2,580	3,060	3,700	3,700
Width	mm	570	730	730	1,050
Height	mm	1,210	1,530	1,850	1,850
Weight	kg	420	560	830	1,050

All air volume flows are based on standard density 1.2 kg/m³.

¹ Volume flow upper limit for compliance with EU Regulation 1253/2014

² Depending on unit equipment and installation height

³ At OA = -12 °C / 90 % r.h.; EA = 22 °C / 40 % r.h.

Functional description

Description

Heat recovery: In case of low outside temperatures the system operates completely in heat recovery mode. The cross-counterflow-cross plate heat exchanger enables the recovery of up to 80 % of the heat contained in the return air. The standard integrated heating coil compensates for ventilation and transmission heat losses of the building as required.

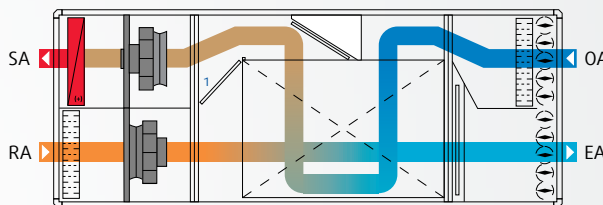

Reduced heat recovery: If the outside air temperature rises, the heat recovery requirement is reduced. The bypass dampers, which run along the entire depth of the unit, are continuously regulated in order to achieve the desired supply air temperature. If the outside temperature continues to rise, the heat recovery is completely bypassed. The design of the bypass reduces the internal pressure drop on the OA-SA path and hence also significantly reduces the power consumption of the fan motor.

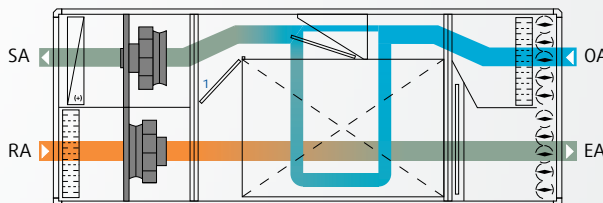

Summertime conditions: If the outside temperature rises above the return temperature, the highly efficient heat exchanger is used as a "cooling recovery system". The warm outside air is cooled by the return air.

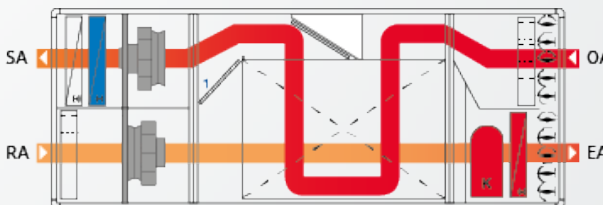

Trisolair 59



Trisolair 59		591801	592601	593601
Optimum flow rate	m ³ /h	1,770	2,550	3,540
Max. volume flow rate ^{1,2}	m ³ /h	2,450	3,140	4,900
Heat recovery efficiency ³	%	81.8	84.7	83.3
Heat recovery efficiency according to EN 308	%	76	79	78
Cooling capacity refrigeration system ⁴	kW	8.6	12.7	17.6
Power consumption	A	19.3	17.7	21.1
Electr. input power	kW	3.8	6.0	7.5
Operating voltage		3 / N / PE 400 V 50 Hz		
Sound power level				
Sound pressure of 1 m from the unit	dB(A)	52	54	53
Connections				
LPHW connections	DN	32	32	32
LPHW control valve	DN	10	10	10
Floor and condensate drains	DN	20	20	20
Dimensions				
Length	mm	4,110	4,750	4,750
Width	mm	730	730	1,050
Height	mm	1,530	1,850	1,850
Weight	kg	770	1,050	1,280

All air volume flows are based on standard density 1.2 kg/m³.

¹ Volume flow upper limit for compliance with EU Regulation 1253/2014

² Depending on unit equipment and installation height

³ At OA = -12 °C / 90 % r.h.; EA = 22 °C / 40 % r.h.

⁴ At OA = 32 °C / 40 % r.h.; EA = 26 °C / 55 % r.h.

Functional description

Description in addition to the Trisolair

Cooling operation type 59:

Where outside air temperatures are sufficiently high, the heat exchanger is used for precooling the outside air (cold recovery). This minimises the electrical capacity required by the integrated compressor refrigeration system, which cools the supply air to the desired temperature and dehumidifies it if required. If unfavourable temperature conditions mean that precooling is not practical, the heat exchanger is bypassed.

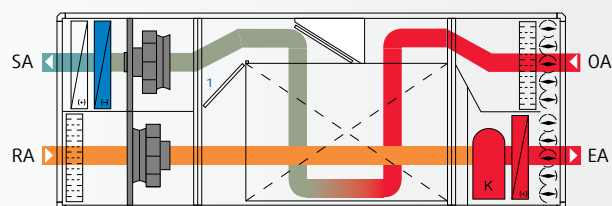

All-in-one concept: Air handling unit with counterflow plate heat exchanger

NX Adconair

- Area of application:** Production facilities, food industry, canteens, exhibition halls, commercial kitchen
- Main functions:** Complete unit ready for connection, which contains all components for low energy ventilation, including all switching and control elements. With the counterflow plate heat exchanger, NX Adconair sets the highest standards in terms of energy efficiency.
- Knowledge:** NX Adconair sets the highest standards with the counterflow plate heat exchanger. The heat exchanger works with a real counterflow proportion of more than 80 % with only 115 Pa pressure loss and at the same time achieves the highest energy efficiency classes. Menerga solutions with an NX Adconair are versatile and can therefore be used in a wide range of applications. Its unique design currently makes it one of the best plate heat exchangers available on the market. The polypropylene material used also allows only pure water to be used for the operation of the adiabatic cooling without the addition of additives, such as cleaning or wetting agents, and thus does not pollute the waste water.

Heat recovery rate over 90 %
with only 115 Pa pressure loss

Heat recovery class H1 even at
high air velocities

Air volume flow:
2,730 – 36,900 m³/h

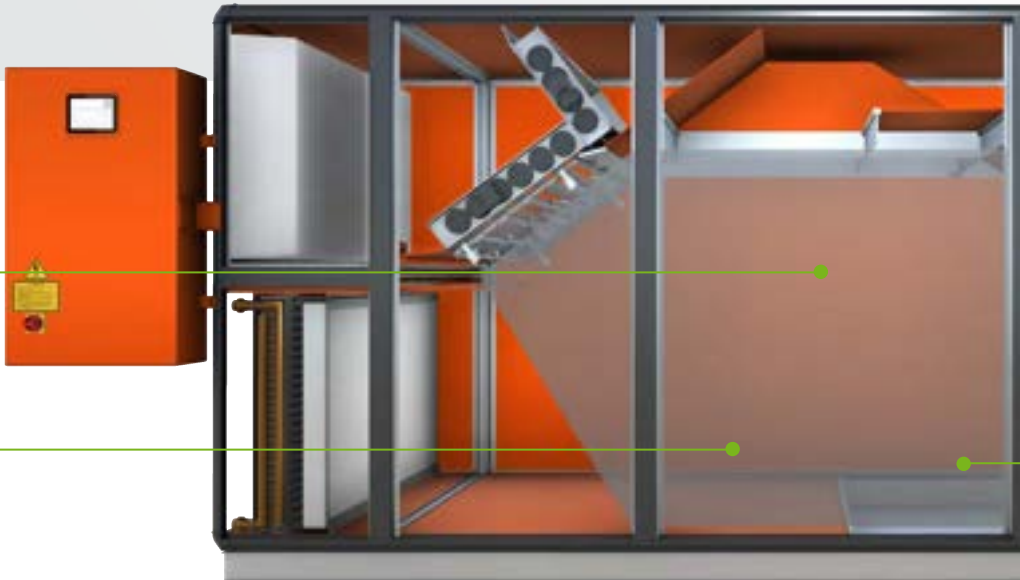

Additional details

Included performance parameters:

- Corrosion-free counterflow plate heat exchanger made of polypropylene
- EC fan motors / Menerga EcoWall
- Heating coil
- Integrated heat recovery bypass for free cooling
- Integrated freely programmable control and control unit
- Freely configurable air handling unit
- Complete unit delivered ready for connection
- Intensive quality inspection with factory test run
- Complete cleaning of the heat exchanger possible without dismantling

Additional options:

- Hybrid adiabatic
- Thermally driven adsorption process for chilled water generation
- Type-tested (PED 2014/68/EU) compression refrigeration system with capacity-controllable scroll compressors and microchannel condensers (with optional hot water and/or cold water extraction possible)
- Continuously controlled recirculation heating flap
- Shortened recuperator (960 mm shorter in length) optimal for minimum space requirement
- Supply air humidification without unit extension
- Larger air volumes on request
- And many more

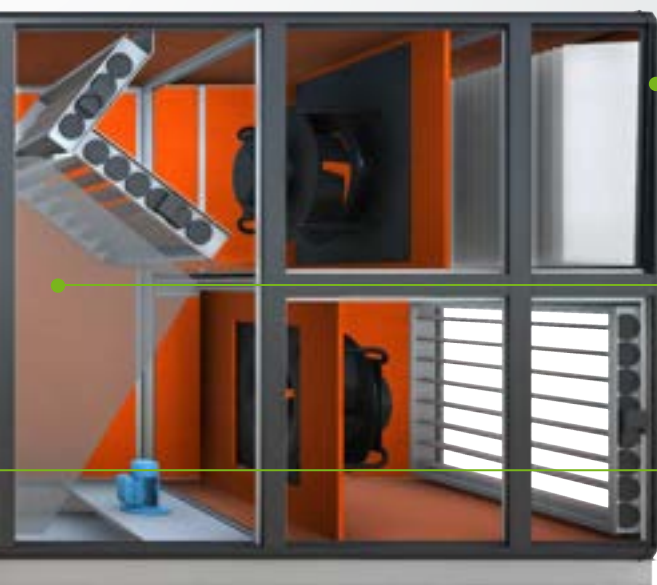

Designed to meet the requirements of the highest energy efficiency classes

Demand-controlled defrost function with low peak power

Natural refrigerants can be used



NX Adconair

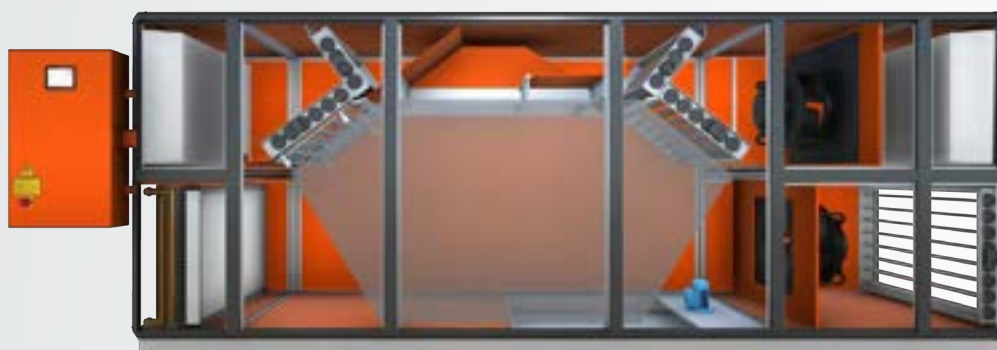

NX Adconair		10.10	15.10	10.15	15.15	20.15
Optimum flow rate ¹	m ³ /h	2,730	4,000	4,000	5,840	7,690
Max. volume flow ²	m ³ /h	4,200	6,300	6,300	9,500	12,700
Heat recovery efficiency ³	%	81.9	82.3	84.7	85.2	85.4
Heat recovery efficiency according to EN 308	%	75.0	76.0	78.0	78.0	78.0
Adiabatic cooling capacity ⁴	kW	11.0	16.1	16.4	24.0	31.6
Power consumption	A	11.4	11.4	11.4	11.4	17.8
Electr. input power	kW	2.3	3.0	3.0	4.3	5.2
Operating voltage		3/N/PE 400V 50Hz				
Volume flow ErP 2018 ⁵	m ³ /h	3,300	4,800	4,850	7,000	9,400

Sound power level

Sound power level 1m from the unit	dB(A)	55	56	56	62	61
------------------------------------	-------	----	----	----	----	----

Connections

LPHW connection	Inch	1 ¼	1 ¼	1 ¼	1 ¼	1 ½
LPHW control valve connection	DN	15	15	15	20	25
Condensate drain	DN	40	40	40	40	40
Floor drain	DN	20	20	20	20	20

Dimensions (for standard configuration)

Length	mm	5,082	5,082	5,682	5,682	5,832
Width	mm	782	1,082	782	1,082	1,382
Height	mm	1,842	1,842	2,442	2,442	2,442
Weight	kg	1,142	1,366	1,499	1,794	2,170

Largest transport unit (with standard configuration)

Length	mm	3,000	3,000	3,600	3,600	3,600
Width	mm	782	1,082	782	1,082	1,382
Height	mm	1,842	1,842	2,442	2,442	2,442
Weight	kg	636	773	918	1,113	1,317
Weight of transport unit	kg	298	353	350	412	547
Weight of transport unit	kg	208	240	231	269	306

All air volume flows are based on standard density 1.2 kg/m³.

¹ At air velocity 1.8 m/s

² Depending on unit equipment and installation height

³ At OA = -12 °C / 90 % r.h.; EA = 22 °C / 40 % r.h.

⁴ At OA = 32 °C / 40 % r.h.; EA = 26 °C / 55 % r.h.

⁵ Volume flow upper limit for compliance with EU Regulation 1253/2014

NX Adconair		25.15	30.15	30.20	35.20	45.20
Optimum flow rate ¹	m ³ /h	9,540	11,380	14,980	17,410	22,270
Max. volume flow ²	m ³ /h	15,900	19,000	23,400	29,000	36,900
Heat recovery efficiency ³	%	85.5	85.6	88.0	88.1	88.2
Heat recovery efficiency according to EN 308	%	78.0	79.0	81.0	81.0	81.0
Adiabatic cooling capacity ⁴	kW	39.0	46.9	62.7	72.9	93.2
Power consumption	A	13.8	17.4	25.2	25.8	29.6
Electr. input power	kW	5.9	8.4	11.4	13.6	17.9
Operating voltage		3/N/PE 400V 50Hz				
Volume flow ErP 2018 ⁵	m ³ /h	11,850	14,000	18,800	22,200	27,500
Sound power level						
Sound power level 1m from the unit	dB(A)	56	66	67	64	68
Connections						
LPHW connection	Inch	1 ½	1 ½	2	2	2
LPHW control valve connection	DN	25	25	32	32	32
Condensate drain	DN	40	40	40	40	40
Floor drain	DN	20	20	20	20	20
Dimensions (for standard configuration)						
Length	mm	5,982	5,982	6,382	6,532	6,432
Width	mm	1,682	1,982	1,982	2,282	2,882
Height	mm	2,442	2,442	3,042	3,042	3,042
Weight	kg	2,591	2,984	3,587	4,175	5,100
Largest transport unit (with standard configuration)						
Length	mm	3,600	3,600	4,100	4,100	4,100
Width	mm	1,682	1,982	1,982	2,282	1,441
Height	mm	2,442	2,442	3,042	3,042	3,042
Weight	kg	1,595	1,732	2,282	2,646	3,347
Weight of transport unit	kg	653	877	855	1,034	1,173
Weight of transport unit	kg	343	375	450	495	580

All air volume flows are based on standard density 1.2 kg/m³.

¹ At air velocity 1.8 m/s

² Depending on unit equipment and installation height

³ At OA = -12 °C / 90 % r.h.; EA = 22 °C / 40 % r.h.

⁴ At OA = 32 °C / 40 % r.h.; EA = 26 °C / 55 % r.h.

⁵ Volume flow upper limit for compliance with EU Regulation 1253/2014

NX Adconair versions

Description

NX Adconair base model: Basic unit without additional equipment. The central element is the counterflow plate heat exchanger. Ideal application areas are those in which a high heat recovery is in the focus.



Additional equipment adiabatic evaporative cooling: Classic adiabatic evaporative cooling with temperature reduction up to 14 K (for RA=26 °C; 55 % r.h., OA=34 °C; 40 % r.h. and optimum air volume flow at standard density). The ideal application area is one with a high demand for cooling and simultaneously high demands for heat recovery, without the need for dehumidification.



Optional: Hybrid adiabatic: By combining the processes of indirect, adiabatic evaporative cooling and dew point cooling, supply air temperatures of down to 18 °C can be achieved. This allows the high removal of high sensible heat loads from the rooms.



Optional: Adsorption cooling: Cooling is provided by an integrated, closed adsorption cooling circuit which supplies the heating coil used for supply air heating in winter with cold water for cooling in summer. As the adsorption cooling circuit is operated thermally, existing waste heat can be used efficiently.



Functional description

Description

Wintertime conditions: In case of low outside temperatures the system operates completely in heat recovery mode. The counterflow plate heat exchanger enables the recovery of more than 90 % of the heat contained in the return air. The standard heating coil compensates for ventilation and transmission heat losses of the building as required.

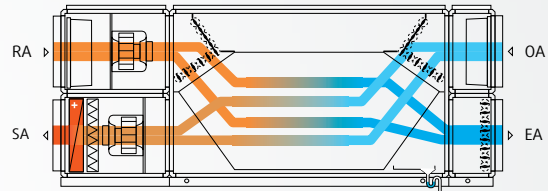

Defrosting circuit: The integrated defrosting circuit melts any ice build-up by opening the extract air-exhaust air bypass, which directs the return air straight to the area of any possible ice without interrupting the fresh air supply. In this way, the peak load on the LPHW for reheating the extremely cold outside air is significantly reduced.

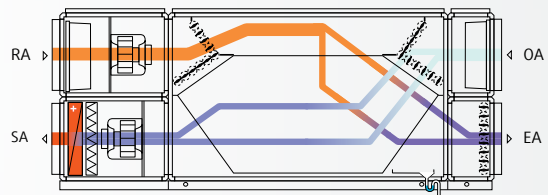

Transitional period: As the outside air temperatures rise, the heat recovery requirement is reduced. The bypass dampers, which run along the entire depth of the unit, are continuously regulated in order to achieve the desired supply air temperature. If the outside temperatures continue to rise, the heat recovery is completely bypassed. The structural design of the bypasses for both airflow paths ensures that the pressure losses within the unit are low and that the power consumption of both fans in bypass mode is also reduced to a minimum. A standard unit will spend more hours in that mode of operation than heating and cooling.

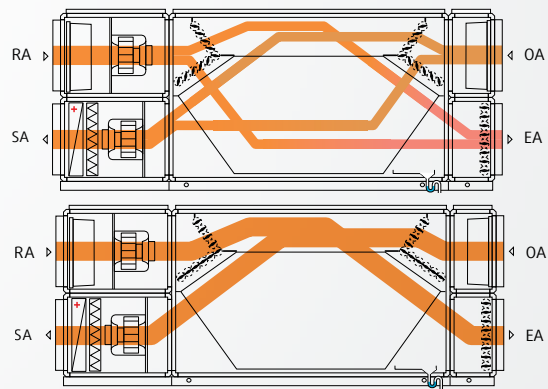

Summertime conditions: If the outside temperature rises above the return air temperature, the highly efficient heat exchanger is used as a "cooling recovery system". The warm outside air is cooled by the return air.

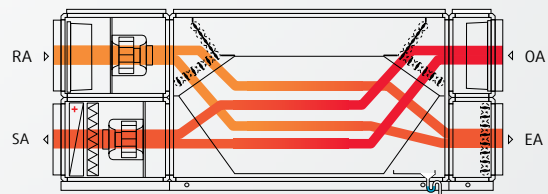

Compressor refrigeration system: At high outside temperatures, both the integrated adiabatic cooling and the compression refrigeration system are activated so that the supply air is cooled to the desired temperature and dehumidified if necessary. The adiabatic system lessens the load of the compression refrigeration system and increases the unit SEER considerably.

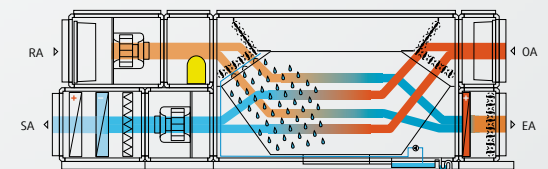

NX Adconair Adiabatic

- Area of application:** Production facilities, food industry, canteens, exhibition halls, commercial kitchen
- Main functions of the version:** An essential component of this function is the counterflow plate heat exchanger, in which the return air is cooled adiabatically.
- Knowledge:** In the counter flow principle, the outdoor air is cooled by the humid and cool exhaust air. Due to a complete separation of the air ways, there is no moisture transfer from the exhaust air to the supply air. The high efficiency is based on the fact that both processes of the adiabatic evaporative cooling of the return air and the cooling of the outside air, take place within the heat exchanger simultaneously. The high temperature efficiency of this plate heat exchanger and the high counterflow proportion of > 80 % ensure a high cooling effect. In this way, a large cooling capacity of the outdoor air, or more than 14 K can be achieved. This variant can be extended by an integrated compression refrigeration system. It is switched on at high outside air temperatures in order to cool the supply air to the desired temperature.

No additional air-side pressure drop resulting from components installed in the air path, e.g. humidifiers	Cooling of outdoor air by up to 14 K possible	Adiabatic cooling efficiency $\Phi_{Adi} > 90 \%$	Operation with rain water possible
Supply air humidification of up to 2-3 g/kg possible	Great output, even with high internal thermal loads	Reduction of the required DX cooling duty by up to 70 %	Minimal water consumption of 2.2 l/person & day during summertime

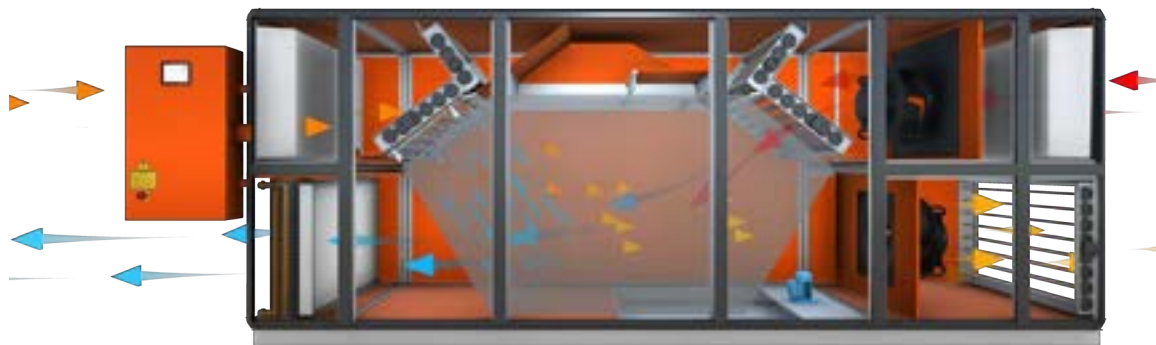

All-in-one concept: Air handling unit with counterflow plate heat exchanger

NX Adconair Adiabatic^{zeroGWP}

- Area of application:** Production facilities, food industry, canteens, exhibition halls, commercial kitchen
- Main functions of the version:** Within the first-half of the heat exchanger, indirect, adiabatic evaporation cooling takes place, as described in the Adconair Adiabatic systems. Outside air is therefore already extensively cooled down. In the second-half of the heat exchanger, so-called dew point cooling takes place.
- Knowledge:** For this purpose, a portion of the pre-cooled outdoor air is diverted after leaving the heat exchanger as process air flow. It is then directed back in to the heat exchanger in accordance with the counterflow principle and again humidified once again. In this way, indirect evaporative cooling takes place again. Unlike conventional systems, the lowest possible temperature is no longer dependent on the wet-bulb temperature of the return air, but rather on the dew-point temperature of the pre-cooled outside air. The process air flow is up to 50 % of the nominal flow and is controlled constantly such that a constant supply air temperature is maintained. This duty impact must be considered during the design phase.

Low water consumption of 3.6 l/kWh	No need for a conventional refrigeration system	Adiabatic cooling efficiency > 115 % (based on the wet-bulb temperature of the extracted air)	Great output, even with high internal thermal loads
Minimal power consumption with a SEER of 36	Adiabatic operation with rain water possible	Cooling of outdoor air by up to 20 K possible	Rising humidity of the return air does not result in notable power reduction



All-in-one concept: Air handling unit with counterflow plate heat exchanger

NX Adconair AdiabaticDX^{carbonfree} thermally

- Area of application:** Production facilities, food industry, canteens, exhibition halls, commercial kitchen
- Main functions of the version:** The key components of this system consist of two modules, which are equipped with silica gel as an adsorption material.
- Knowledge:** The physical process of adsorption produces cold water, which is used in a change-over coil to cool and dehumidify the supply air. The flow temperatures from the refrigeration circuit are low enough to cool the outside air from 32 °C down to around 16 °C, in combination with indirect, adiabatic evaporative cooling. While one module generates the cold water by this process, the second module is regenerated. For this purpose, hot water (from 55 °C) is applied, which leads to desorption of the saturated silica gel. The desorption is at least as fast as the adsorption, so that enough cooling energy is always available. The special feature of this concept is that there are no mechanically moving parts in the vacuum and the noise level is extremely low and vibration-free compared to conventional compressors.

No certified refrigeration technicians for maintenance needed	Hydraulically separated heat and cold supply, no mixing possible	Minimal water consumption of 2.5 l/person & day during summertime	No additional energy consumption for supply air cooling and dehumidifying
Is not subject to the F-Gas regulation	Adiabatic operation with rain water possible	FC-free, as water is used as refrigerant with GWP = 0	Operating heat for adsorption process from 55 °C
			Possible energy sources: solar heat, district heating, waste heat from combined heat and power plants, process heat

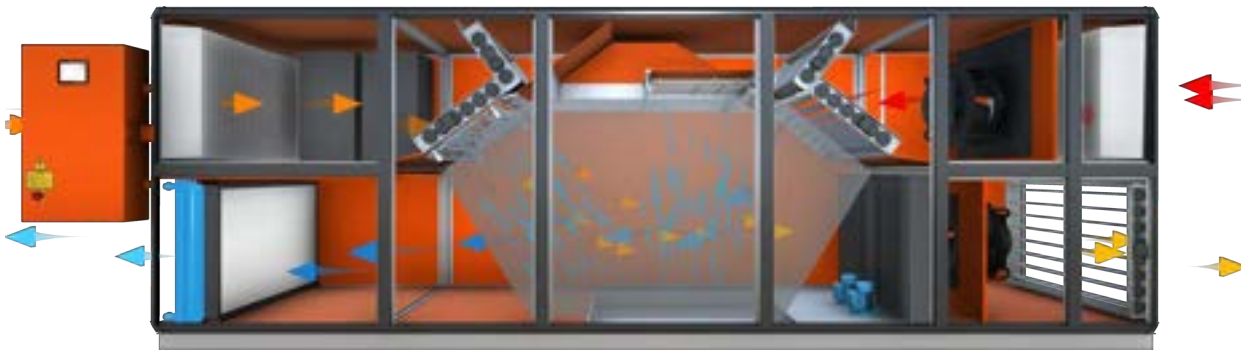



IBVTIKON - Application area: office and administration buildings, Germany

All-in-one concept: Air handling unit with double plate heat exchanger and adiabatic evaporative cooling

NX Adsolair

- Area of application:** Laboratories, commercial kitchens, production facilities with contaminated exhaust air, data centres
- Main functions:** Complete unit ready for connection, contains all components for low energy ventilation, including all switching and control elements.
- Knowledge:** Requirements with high thermal loads can be ideally met with the different cooling options of the units in series Adsolair. Series 56 uses adiabatic evaporative cooling and achieves to cool up to 12 K (at OA = 34 °C / 40 % r.h.) with water. The total cooling capacity is further enhanced with an integrated compression refrigeration system.

Air volume flow:
2,200 – 40,800 m³/h

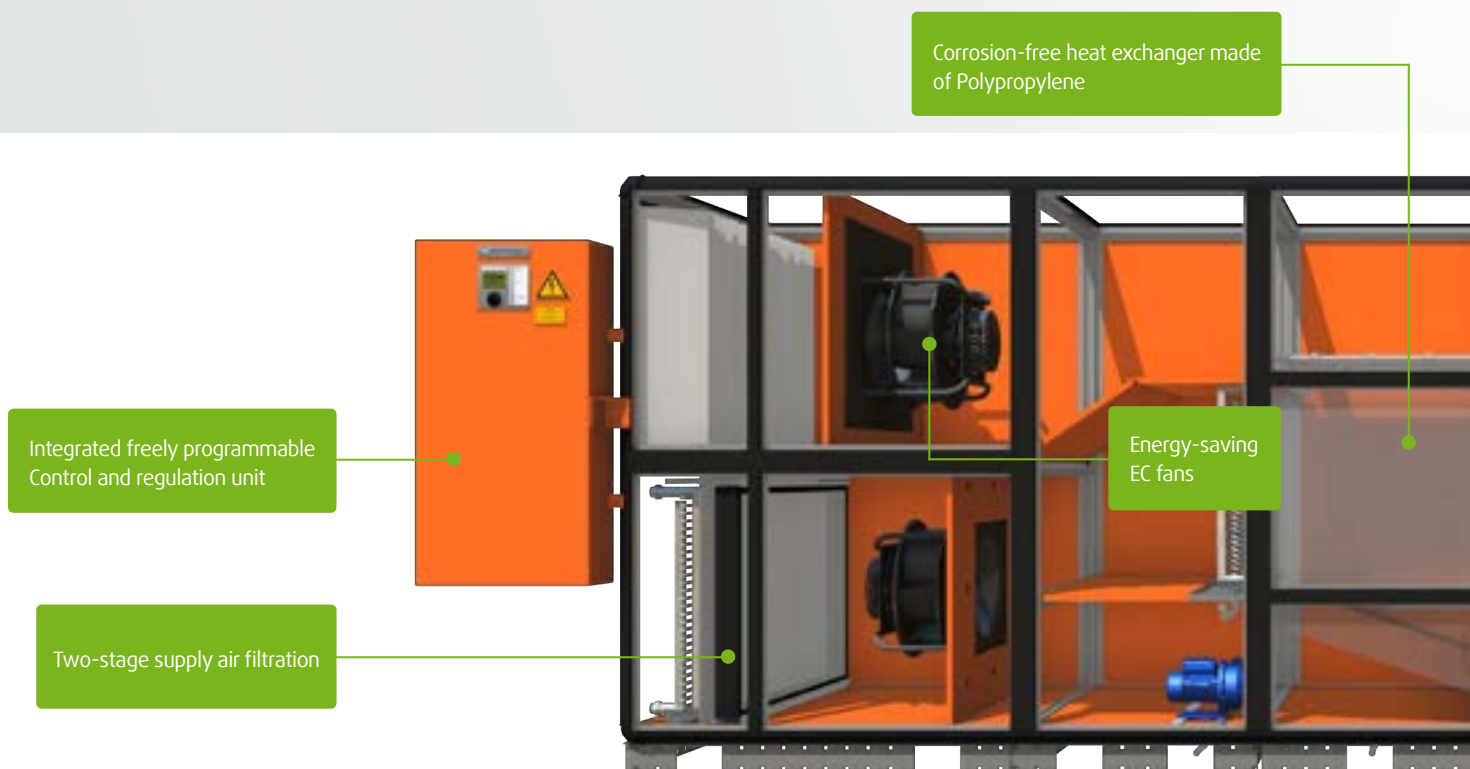

Additional details

Included performance parameters:

- Filtering of the air in every operating mode
- Corrosion-free heat exchanger made of Polypropylene
- Pump hot water heating coil
- Thermal bridge factor TB1
- Individually adjustable performance parameters
- Intensive quality testing with factory test run

Additional options:

- Recirculation heating damper
- Pump cold water cooling coil (Series 56)
- Pressure reversal
- Attenuator
- Reversible refrigeration system (Series 58)
- Outdoor installation
- Hot water extraction to use the waste heat for heating purposes (Series 58)
- Increase in cooling capacity
- Remote maintenance
- Larger air volumes on request
- And many more

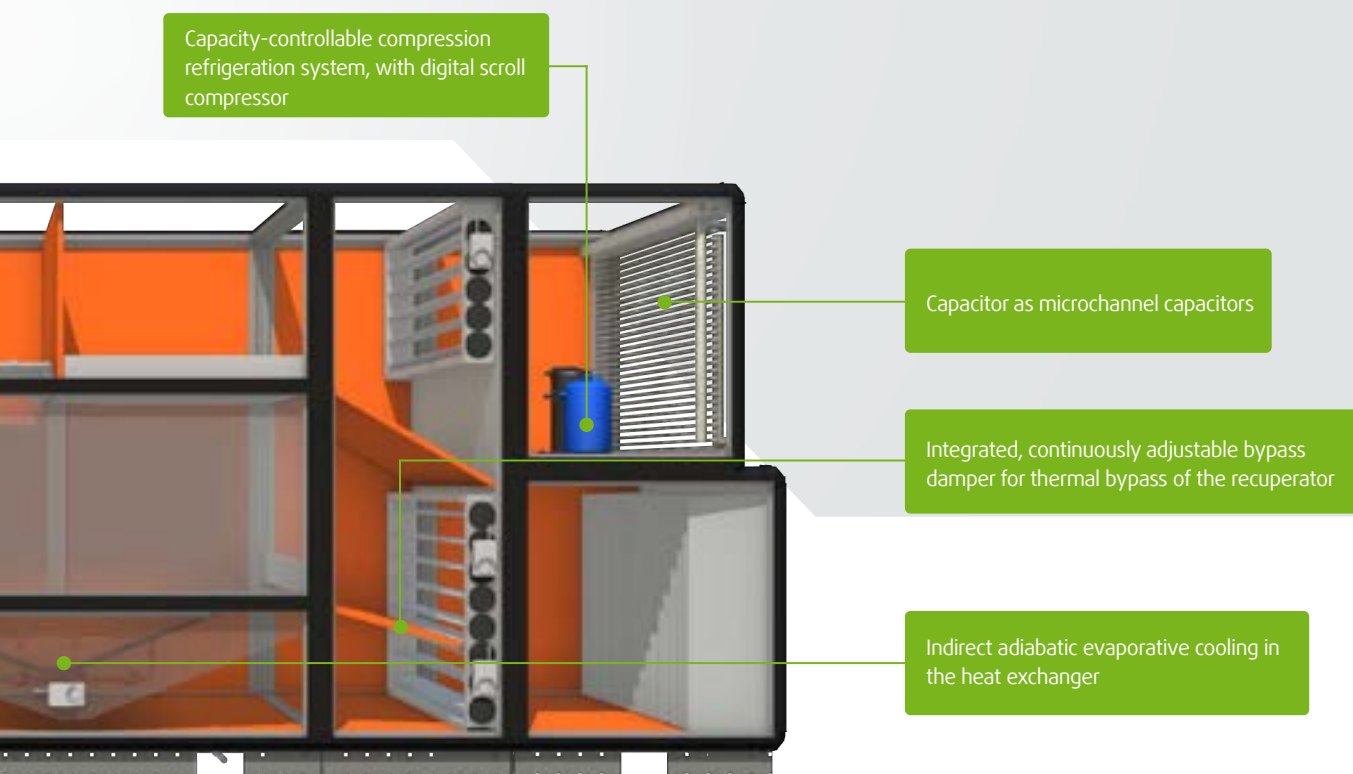

NX Adsolair 56



NX Adsolair 56		56 03 01	56 05 01	56 06 01	56 10 01	56 13 01	56 16 01	56 19 01	56 25 01	56 32 01	56 36 01
Optimum volume flow	m ³ /h	2,200	3,200	3,800	5,500	7,300	9,100	10,900	12,800	16,800	19,900
Max. Volume flow	m ³ /h	2,200	3,200	4,200	6,000	7,900	9,900	11,800	15,000	19,800	22,800
Energy efficiency according to EN13053:2012	%	71	71	73	73	73	73	73	77	74	74
Heat recovery efficiency according to EN 308	%	72.3	72.3	75.5	75.8	75.7	75.8	75.7	80	76.8	76.6
Power consumption	A	9.1	9.1	9.1	10.7	17.4	17.4	18.8	33.6	33.6	39.7
Cooling capacity adiabatic	kW	7.9	11.7	13.6	19.8	26.6	32.7	39.1	48.3	61.0	72.1
Electr. input power ¹	kW	1.76	2.3	2.76	3.82	4.95	5.92	7.97	10.26	13.46	16.2
Operating voltage ¹		3 / N / PE 400 V 50 Hz									

Connections

LPHW connection	DN	32	32	32	32	40	40	40	50	50	65
LPHW control valve connection	DN	15	15	15	15	15	15	20	25	25	25
Condensate	DN	40	40	40	40	40	40	40	40	40	40
Floor drains	DN	40	40	40	40	40	40	40	40	40	40

Sound power level

Sound power 1m from the unit	dB(A)	40	42	43	47	42	47	55	49	53	57
------------------------------	-------	----	----	----	----	----	----	----	----	----	----

Dimensions

Length	mm	4,510	4,670	5,790	5,790	5,950	5,950	5,950	6,590	7,390	7,390
Width	mm	790	1,110	790	1,100	1,430	1,750	2,070	2,070	2,070	2,390
Height	mm	1,700	1,700	2,340	2,340	2,340	2,340	2,340	2,980	3,620	3,620
Weight	kg	1,120	1,370	1,570	1,880	2,230	2,560	2,840	3,840	4,700	5,280

Largest transport unit

Length	mm	2,670	2,670	3,790	3,790	3,790	3,790	3,790	4,430	5,230	5,230
Width	mm	790	1,110	790	1,110	1,430	1,750	2,070	2,070	2,070	2,390
Height	mm	620	770	970	1,150	1,340	1,540	1,720	2,440	3,150	3,550

Specifications of technical data relate to the optimum flow rate and return air condition 22 °C / 40 % r.h., outside air condition -12 °C / 90 % r.h. and standard density (1.204 kg/m³), unless otherwise specified.

¹ Dependent on configuration of measurement and control system/unit

Functional description

Description

Wintertime conditions: In case of low outside temperatures the system operates in full heat recovery mode. The standard heating coil (LPHW) compensates for ventilation and transmission heat losses of the building as required.

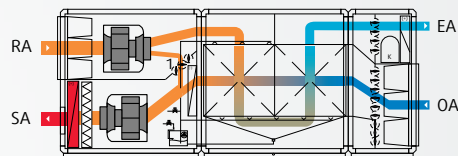

Defrosting circuit: All recuperative heat exchangers tend to ice over in the exhaust air section with low outside temperatures. In defrost operation, the OA-SA bypass opens, reducing the outside air flow rate going through the recuperator. The heat contained in the return air melts any ice in the heat exchanger, while the airflow rate routed through the recuperator is regulated as required.

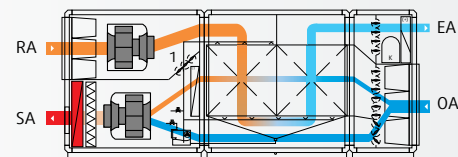

Transitional period: As the outside air temperature rises, the heat recovery demand is reduced. The OA/SA bypass damper, which runs the entire depth of the unit, is continuously regulated in order to achieve the desired supply airtemperature.

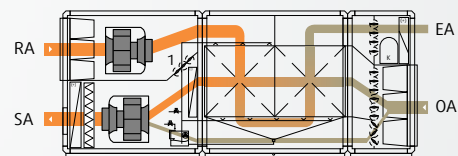

Free cooling: If the outside temperature continue to rises, the heat recovery is bypassed. The structural design of the OA/SA bypass ensures that the pressure losses within the unit are low and that the power consumption of both fans in bypass mode is also low.

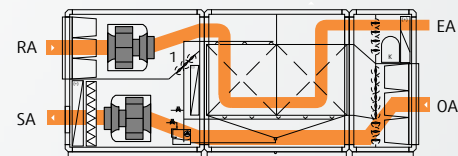

Summertime conditions: If the outside temperature rises above the return temperature, the highly efficient heat exchanger is used as a „cooling recovery system“. The warm outside air is cooled by the return air.

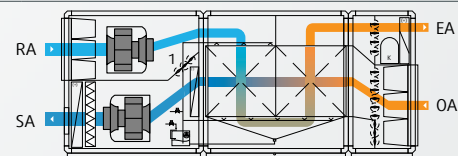

Indirect adiabatic evaporative cooling: The Menerga Adsolair principle uses the advantages of indirect adiabatic evaporative cooling without the disadvantages of supply air humidification. A major component of the Adsolair principle is the double plate heat exchanger, in which the return air is adiabatically cooled. In return, the outside air is cooled by the humid, cold exhaust air, without being humidified. The high efficiency rate lies in the fact that both processes (adiabatic evaporative cooling of the return air + cooling of the outside air) take place simultaneously in the heat exchanger. The high degree of temperature efficiency of the double plate heat exchanger allows significant cooling of the OA-SA by over 12 K (at OA = 34 °C / 40 % r.h.). If required, the compressor refrigeration system will switch on and cool the supply air even further.

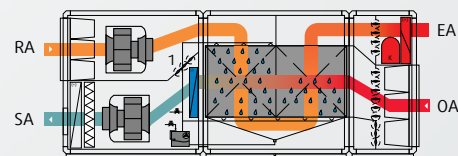

NX Adsolair 58

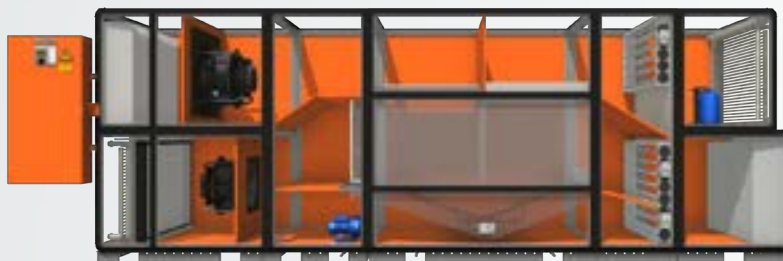

NX Adsolair 58		58 03 01	58 05 01	58 06 01	58 10 01	58 13 01	58 16 01	58 19 01	58 25 01	58 32 01	58 36 01
Optimum volume flow	m ³ /h	2,200	3,200	3,800	5,400	7,300	9,100	10,900	12,700	16,700	19,900
Max. Volume flow	m ³ /h	2,200	3,200	4,200	5,950	7,900	9,950	11,800	14,800	19,500	22,500
Total cooling capacity ¹	kW	16.5	23.30	23.6	35	44.9	57.2	69.8	83.7	106.5	120.2
Total cooling capacity number ^{1,2}	EER	6.9	8.3	10.3	10.3	11.5	10.0	10.0	10.7	11.0	12.8
Energy efficiency according to EN 13053:2012	%	71	71	73	74	73	73	73	77	74	74
Heat recovery efficiency according to EN 308	%	72.3	72.3	75.5	76	75.7	75.8	75.7	80.1	76.9	76.6
Power consumption ³	A	16.1	17.3	16.4	21.2	29.4	34.6	39.1	55.9	66.2	71.8
Cooling capacity adiabatic	kW	7.9	11.7	13.6	19.4	26.2	32.7	39.1	47.9	60.6	72.1
Electr. input power ³	kW	4.0	4.9	4.9	7.0	8.7	11.4	14.7	17.8	23.0	25.0
Operating voltage	3/N/PE 400V 50Hz										

Connections

PWW connection	DN	32	32	32	32	40	40	40	50	50	65
PWW control valve connection	DN	15	15	15	15	15	15	20	25	25	25
Condensate drain	DN	40	40	40	40	40	40	40	40	40	40
Floor drain	DN	40	40	40	40	40	40	40	40	40	40

Sound power level

Sound power level 1m from the unit	dB(A)	41	42	43	47	42	47	54	49	54	57
------------------------------------	-------	----	----	----	----	----	----	----	----	----	----

Dimensions

Length	mm	4,830	4,990	6,110	6,110	6,270	6,270	6,270	6,910	7,710	7,710
Width	mm	790	1,110	790	1,100	1,430	1,750	2,070	2,070	2,070	2,390
Height	mm	1,700	1,700	2,340	2,340	2,340	2,340	2,340	2,980	3,620	3,620
Gewicht	kg	1,320	1,620	1,800	2,130	2,590	2,830	3,340	4,440	5,400	6,400

Weight Largest transport unit

Length	mm	2,670	2,670	3,790	3,790	3,790	3,790	3,790	4,430	5,230	5,230
Width	mm	790	1,110	790	1,110	1,430	1,750	2,070	2,070	2,070	2,390
Height	mm	1,700	1,700	2,340	2,340	2,340	2,340	2,340	2,980	3,620	3,620

Specification of technical data refers to optimum volume flow and extract air condition 22 °C / 40 % r.h., fresh air condition -12 °C / 90 % r.h. and standard density (1.204 kg/m³), unless otherwise stated.

² Incl. evaporative cooling capacity taking into account power consumption for adiabatic pump(s)

³ Dependent on configuration of measurement and control system/unit

¹ With extract air 26 °C; 55 % r.h. and outside air 32 °C; 40 % r.h.



Fensch GmbH - Specialists for high-quality and particularly long-lasting LED luminaires, Germany

All in one concept: Air handling unit with highly efficient regenerative accumulators

NX Resolair

- 📍 **Area of application:** Warehouses, production halls, exhibition halls
- ⚠️ **Main functions:** Units in the NX Resolair series operate with medium and large air volumes with the advantages of regenerative heat recovery.
- ⚙️ **Knowledge:** Capable of more than 90 % heat recovery and up to 70 % moisture recovery enabling a comfortable climate with the lowest energy costs. Due to the very high heat recovery, an external heat supply can be eliminated in many cases. The units have a very high degree of flexibility with regard to partitioning, extensions and optional functions, among other things due to their modular design.

Air volume flow:
3,900 – 51,000 m³/h

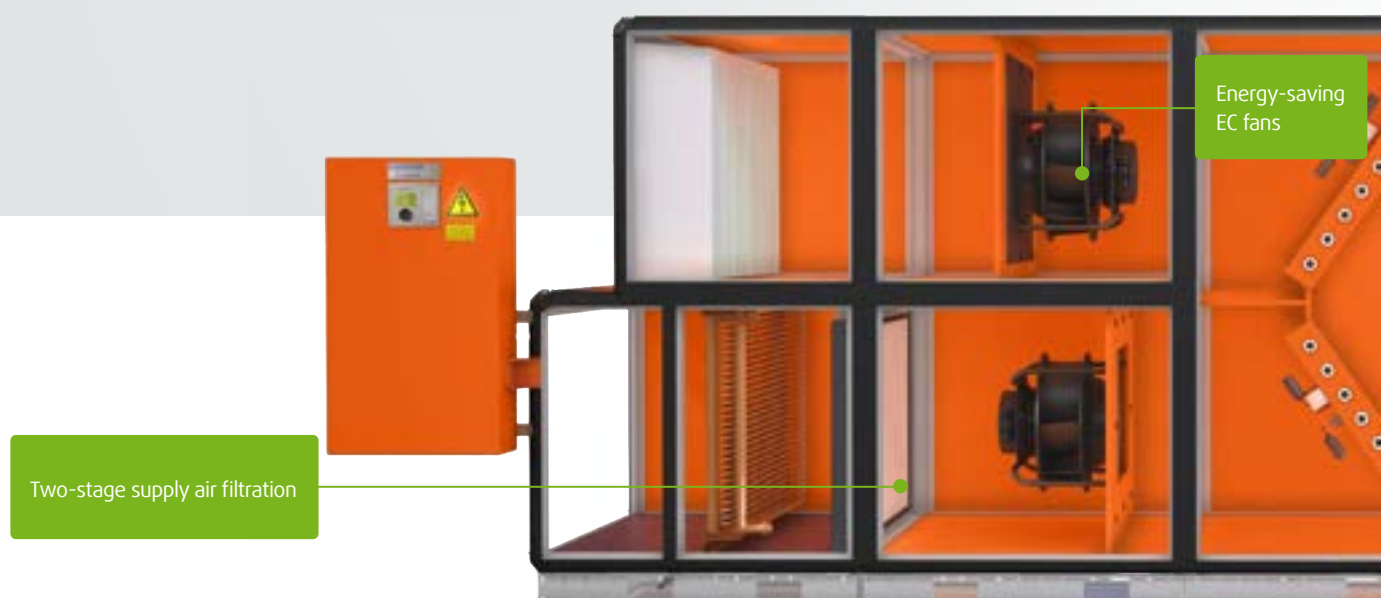

Additional details

Included performance parameters:

- Filtering of the air in all operating modes
- Cycle time change for modes between bypass and free cooling
- Integrated bypass function
- Thermal bridge factor TB1
- Individually adjustable performance parameters
- Complete unit ready for connection, Contains all components for low energy ventilation, including all switching and control elements
- Intensive quality test with factory test run

Options:

- Recirculation heating damper
- Heating coil
- Attenuator
- Type-tested (PED 2014/68/EU) compression refrigeration system with capacity-controllable scroll compressors and microchannel condensers (with optional hot water and/or cold water extraction possible)
- Outdoor installation
- Remote maintenance
- Double dephionaccumulator for enhanced heat recovery
- and many more

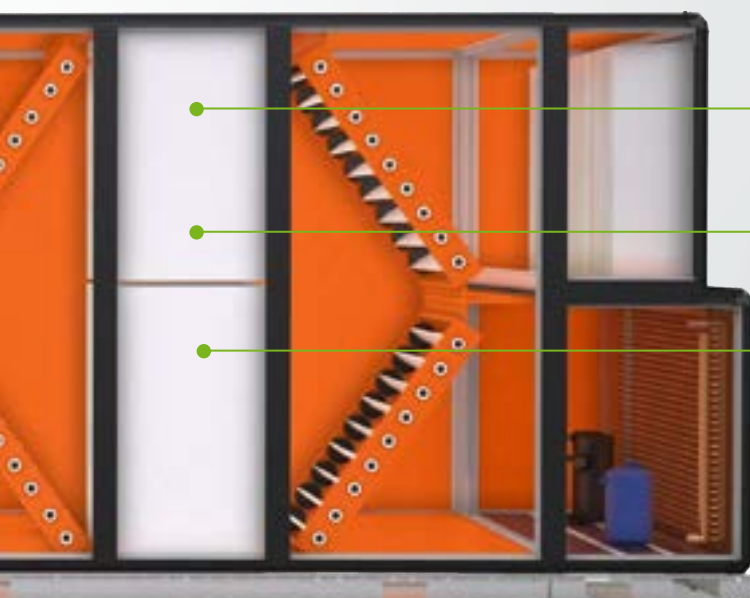

Corrosion-free accumulators made from polypropylene

For heat and cooling coils

Humidity recovery up to 70 %



NX Resolair 64



NX Resolair 64		64 05 01	64 07 01	64 10 01	64 12 01	64 15 01	64 21 01	64 26 01	64 32 01
Optimum volume flow	m ³ /h	3,900	6,000	7,900	9,800	11,800	15,800	19,900	23,100
Max. Volume flow ¹	m ³ /h	6,000	8,500	10,500	13,500	16,000	22,000	25,000	32,800
Cooling recovery ²	kW	6.3	9.7	12.7	15.7	18.7	24.9	31.2	36.9
Energy efficiency according to EN 13053:2012	%	87.6	87.3	87.4	86.9	86.6	86.6	86.7	86.9
Heat recovery efficiency acc. to EN 308	%	86	85	85	85	85	85	85	85
Humidity recovery		up to 70 %							
Power consumption ³	A	8.0	9.6	16.0	16.0	17.4	32.0	34.8	37.6
Electr. input power ³	kW	2.3	3.6	5.2	6.1	8.2	11.7	15.4	17.1
Operating voltage		3 / N / PE 400 V 50 Hz							
Sound power level									
Sound power 1m from the unit	dB(A)	48	54	55	57	60	59	61	62
Dimensions									
Length	mm	4,330	4,650	4,810	4,810	4,970	5,610	5,930	5,930
Width	mm	1,110	1,110	1,430	1,750	2,070	2,070	2,070	2,390
Height	mm	1,700	2,340	2,340	2,340	2,340	2,980	3,620	3,620
Weight	kg	1,300	1,650	2,050	2,350	2,600	3,550	4,000	4,400
Largest transport unit									
Length	mm	2,330	2,650	2,650	2,650	2,810	3,450	3,770	3,770
Width	mm	1,110	1,110	1,430	1,750	2,070	2,070	2,070	2,390
Height	mm	1,700	2,340	2,340	2,340	2,340	2,980	3,620	3,620
Weight	kg	700	960	1,220	1,370	1,550	2,200	2,600	2,800

Specification of the technical data refers to optimum volume flow and extract air condition 22 °C / 40 % r.h., fresh air condition -12 °C / 90 % r.h. and standard density (1.204 kg/m³), unless otherwise stated.

¹ May require modification of technical equipment

² With RA = 26 °C / 55 % r.h., OA = 32 °C / 40 % r.h. with standard density

³ Dependent on configuration of measurement and control system/unit

Functional description

Cycle 1

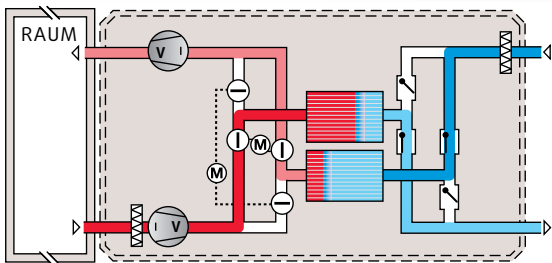

The unit contains two accumulator blocks with highly sensitive accumulator mass, through which the outside and return air pass alternately. The accumulator mass is able to capture heat from a warm air flow very rapidly and transferring this just as rapidly to the cold air flow.

A damper system is installed upstream and downstream of the accumulators. The exhaust/supply air system is driven by electric motors, the outside/exhaust air system works dynamically. The fans in the extract air and supply air sections simultaneously move cold outside air through one package block and warm extract air through the other. The heat from the extract air is stored in one block, while at the same time the heat stored in the other one is released to the outside air.

The temperature efficiency of the regenerative energy exchanger is over 90 %. The unit thus recovers almost all the heat energy of the extract air. This means that a supply air reheating coil is not required if static heating is present or the transmission heat demand is covered by the internal heat load. Despite the very high heat recovery efficiency of the Resolair series, no defrosting operation is necessary due to the regenerative heat recovery system used. The additional heating capacity normally needed is not required in this case.

Under winter conditions, the humidity recovery of the regenerative heat recovery system is up

Cycle 2

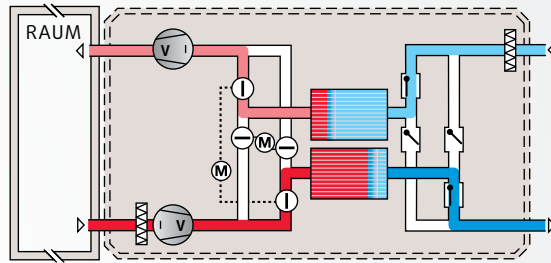

to 70 %, which in most applications makes an additional humidification system unnecessary.

Where outside air temperatures are rising, variable alteration of the switching cycles allows heat recovery to be reduced all the way to the point of free cooling.

If the outside temperature exceeds the room air temperature, the unit switches back to basic operation and then operates in „cooling recovery mode“ with the same high efficiency as in heat recovery.

To remove higher internal heat loads at high outside air temperatures, the integrated compression refrigeration system is switched on (series 68).

NX Resolair 68



NX Resolair 68		68 05 01	68 07 01	68 10 01	68 12 01	68 15 01	68 21 01	68 26 01	68 32 01
Optimum flow rate	m ³ /h	3,900	6,000	7,900	9,800	11,800	15,800	19,900	23,100
Max. volume flow rate ¹	m ³ /h	6,000	8,500	10,500	13,500	16,000	22,000	25,000	32,800
Cooling recovery system ²	kW	6.3	9.7	12.7	15.7	18.7	24.9	31.2	36.9
Energy efficiency according to EN 13053:2012	%	87.6	87.3	87.4	86.9	86.9	86.6	86.7	86.9
Heat recovery rate according to EN 308	%	86.0	85.0	85.0	85.0	85.0	85.0	85.0	85.0
Recovery of humidity		up to 70 %							
Power consumption ¹	A	23.0	34.2	47.0	47.0	60.8	76.0	102.8	112.0
Electr. input power ¹	kW	7.86	10.8	16.0	16.5	22.4	27.2	40.9	42.0
Operating voltage		3/N/PE 400V 50Hz							

Sound power level

Sound power 1m from the unit	dB(A)	43	43	49	44	50	55	50	57
------------------------------	-------	----	----	----	----	----	----	----	----

Dimensions

Length	mm	5,380	5,700	5,860	6,020	6,180	6,980	7,300	7,300
Width	mm	1,110	1,110	1,430	1,750	2,070	2,070	2,070	2,390
Height	mm	1,700	2,340	2,340	2,340	2,340	2,980	3,620	3,620
Weight	kg	1,750	2,150	2,700	3,050	3,500	4,450	5,100	5,500

Largest transport unit

Length	mm	2,330	2,650	2,650	2,650	2,810	3,450	3,770	3,770
Width	mm	1,110	1,110	1,430	1,750	2,070	2,070	2,070	2,390
Height	mm	1,700	2,340	2,340	2,340	2,340	2,980	3,620	3,620
Weight	kg	720	980	1,250	1,400	1,570	2,220	2,620	2,820

Specifications of technical data relate to the optimum flow rate and return air condition 22 °C / 40 % r.h., outside air condition -12 °C / 90 % r.h. and standard density (1,204 kg/m³), unless otherwise specified.

¹ May require alteration of the technical equipment

² At OA = 26 °C / 55 % r.h., RA = 32 °C / 40 % r.h. and standard density

³ Depends on configuration of measurement and control system/unit



Office building “etrium” - has been awarded the golden seal of quality by the German Sustainable Building Council (DGNB). The building is tempered by a Resolair central ventilation unit from Menerga, which is equipped with a highly efficient heat recovery system and supplies the individual building sections with an air volume flow of up to 14,000 m³/h. Via two heat packages with highly sensitive accumulator mass, the system can very quickly absorb the heat present in the extract air flow and just as quickly release it again to the cold supply air.





Area of Application: Special Solutions

102 **Special applications**

108 **Drysolair 11**

Air dehumidification unit with cross counterflow plate heat exchanger and heat pump

110 **NX Adsolair kitchen**

Ventilation of large kitchens and rooms with polluted exhaust air

Unit overview

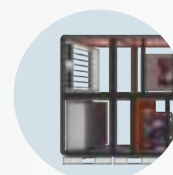

Special Applications

NX Adsolair Kitchen

Food industry	Hygienic room air ensures the quality of the products. Dehumidification of the room air is often a must.	+++
Archives	Precision climates with tight tolerances make high-performance measurement and control system technology indispensable.	
Ventilation with polluted exhaust air	Whether it's a laboratory or an industrial hall, high-tech equipment such as the self-cleaning function or plastic lining are in demand.	+++



Drysolair

++

++

- + Good
- ++ Excellent
- +++ Best in Class

Products at a glance

To help you understand the application range of our products at a glance, we have created an evaluation table to help you make the right choice for your individual requirements.

This evaluation table is designed to help you select the right ventilation solution for your specific requirements. If you have any questions or are unsure, our experts will be happy to help you with your decision.

Menerga rating system

Good: This rating indicates that our air handling units perform solidly in this application area. They meet basic requirements and are a reliable choice for normal applications.

Excellent: Air handling units with this rating exceed the standards and offer above-average performance in this area. They are ideal for situations where improved efficiency and performance is required.

Best in Class: Our air handling units with this rating represent the ultimate in this application area. They offer outstanding performance, innovative technology and maximum efficiency. If you are looking for the best of the best, these are the solutions to meet your needs.

Tailored ventilation solutions

Outstanding technology for special requirements

In the midst of the diverse demands placed on us by the modern world, we at Menerga have created a vision that is second to none. Our products and solutions not only meet standards, but also excel in extraordinary scenarios - in environments where climatic conditions are not only a challenge, but also an opportunity for the highest performance. Here, we understand that no two environments are alike, and that's why we specialize in creating customized solutions that fit seamlessly into the specifics of each industry.

Cooling

Dehumidify

Ventilate

Precise temperature conditions

Food Industry

Our ventilation technology for the food industry not only ensures precise temperature and humidity control, but also meets the highest hygiene standards. From preserving fresh produce to supporting food safety, we offer solutions that meet the unique needs of this demanding industry.

Archives

An optimal environment is critical for the preservation of valuable documents and artifacts. Our archives ventilation technology provides stable temperature and humidity conditions to preserve cultural heritage and sensitive information.

Datacenter

Climate control in data centers is essential. Our

technology ensures precise cooling and heat dissipation to create a stable environment for sensitive IT infrastructures. We maximize the energy efficiency and performance of your data centers with innovative solutions.

Ventilation with polluted exhaust air

In areas with polluted air, we develop solutions that improve air quality and effectively remove harmful particles. Our advanced filtration systems ensure a healthy and safe working environment.

Process cooling

Our process cooling ventilation technology not only optimizes thermal control, but also increases the





efficiency of industrial operations. We provide solutions that ensure precise cooling and temperature management.

Ice halls

Optimal climatic conditions are crucial here. Our ventilation technology provides precise control of ambient temperature and humidity to ensure ideal ice skating conditions. From preventing condensation to creating a comfortable atmosphere, Menerga offers customized solutions that enhance the skating experience every season.

Bakeries

Precise climatic conditions are essential in bakeries. Our specialized ventilation technology ensures optimal humidity and temperature to preserve the

quality of your baked goods. We understand the requirements of the industry and offer solutions that meet the specific needs of bakeries.

All in one concept: Air dehumidification unit with cross counterflow plate heat exchanger and heat pump

Drysolair

- Area of application:** Ice rinks, food production, fish farms, pharmaceutical industry, greenhouses, wood processing industry, bakery
- Main functions:** Complete unit ready for connection, includes all components for air dehumidification for all drying applications with cross-flow plate heat exchanger and heat pump.
- Knowledge:** Units in the Drysolair series were developed especially for discharging high levels of internal moisture to the atmosphere. Through the pre-cooling in the recuperator of the air to be dried, the unit works with considerably lower compressor performance than a simple heat pump system and creates a consistently good climate in ice rinks, the drying of buildings or industrial drying processes. The combination of first-class components with precise control and regulation guarantees economical operation at all times and adjusts the temperature and humidity as required.

Air volume flow:
1,000 – 6,000 m³/h

Integrated control and regulation,
compatible with all common BMS systems

Low connected load due to
Upstream connection of a recuperator

Corrosion-free cross counterflow plate
heat exchanger made from polypropylene



Additional details

Included performance parameters:

- Specific power consumption of less than 500 Wh/kg dehumidification capacity
- Air filtration
- Corrosion-free heat exchanger made of polypropylene
- Individually adjustable performance parameters
- Complete unit ready for connection, contains all components for industrial air-conditioning, including all switching and control elements.
- Intensive quality testing with factory test run

Additional options:

- Room humidity control
- Hot water condenser
- Remote maintenance
- And many more



Energy-saving
EC fans

Compact
design

All in one concept: Air dehumidification unit with cross counterflow plate heat exchanger and heat pump

Drysolair

Drysolair		11 10 01	11 15 01	11 40 01	11 60 01
Optimum flow rate	m ³ /h	1,000	1,500	4,000	6,000
Max. current consumption ²	A	9.1	11.9	18.5	24.2
Operating voltage		3 / N / PE 400 V 50 Hz			
External pressure loss					
Supply and return air channel	Pa	300	300	300	300
Connections					
Condensate drainage	DN	25	25	25	25
Sound power level					
Sound power level 1m from the unit ⁵	dB(A)	50	47	50	56
Air inlet 20 °C / 70% r.F. ¹					
Dehumidification capacity ⁴	kg/h	4.5	6.8	17.6	21.6
Heating capacity	kW	4.7	7.5	18.3	23.4
Specific dehumidification energy requirement	Wh/kg	382	443	386	455
Total power rating	kW	1.7	3.0	6.8	9.8
Compressor input power	kW	1.2	2.3	5.5	7.1
Fan motor input power ³	kW	0.5	0.7	1.3	2.7
SFP - Category		4	4	3	4
Air inlet 10° C / 85% r.h. ¹					
Dehumidification capacity ⁴	kg/h	2.7	4.4	10.6	12.9
Heating capacity	kW	2.8	4.4	10.3	13.4
Specific dehumidification energy requirement	Wh/kg	411	407	370	485
Total power rating	kW	1.1	1.8	3.9	6.3
Compressor input power	kW	0.6	1.1	2.7	3.6
Fan motor input power ³	kW	0.5	0.7	1.2	2.7
SFP - Category		4	4	3	4
Dimensions					
Length	mm	730	730	1,050	1,050
Width	mm	730	730	1,050	1,050
Height	mm	2,245	2,245	2,725	2,725
Weight	kg	450	450	660	680

¹ Other configurations on request

² Dependent on configuration of measurement and control system/unit

³ With medium filter contamination

⁴ Observe reduction of dehumidification performance due to defrosting intervals

⁵ At 250 Hz centre frequency

All technical data relate to optimum flow rate through heat recovery system and the air inlet conditions specified above and at standard density (1.204 kg/m³).

Functional description

In recirculation mode humid air is dehumidified in two stages and supplied into the room as dry supply air. The return air is pre-cooled and dehumidified in the plate heat exchanger.

Climate solution from Menerga

The dehumidification to the desired supply air humidity level takes place by means of cooling the air to below its dew point in the evaporator of the heat pump. The air that has been dried in this manner is then warmed back up again in the condenser of the heat pump using its own heat, which was removed during cooling, and is brought to the required condition. The pre-cooling in the plate heat exchanger of the air to be dried means that the air dehumidification unit operates with a considerably lower compressor performance and hence a significantly lower energy consumption than a simple heat pump solution. The integrated bypass allows fast and precise control and adjustment to the condition of the return air. The cooling capacity is thus continuously adapted to the respective requirements.

Specific dehumidification energy requirement

Drysolair achieves a specific dehumidification energy requirement of far less than 500 Wh/kg. With one kilowatt hour of electrical energy, it is therefore possible to remove more than 2 kg of humidity from the recirculation air. In contrast, classical solutions without integrated heat recovery systems reach peak values in excess of 1,000 Wh/kg.

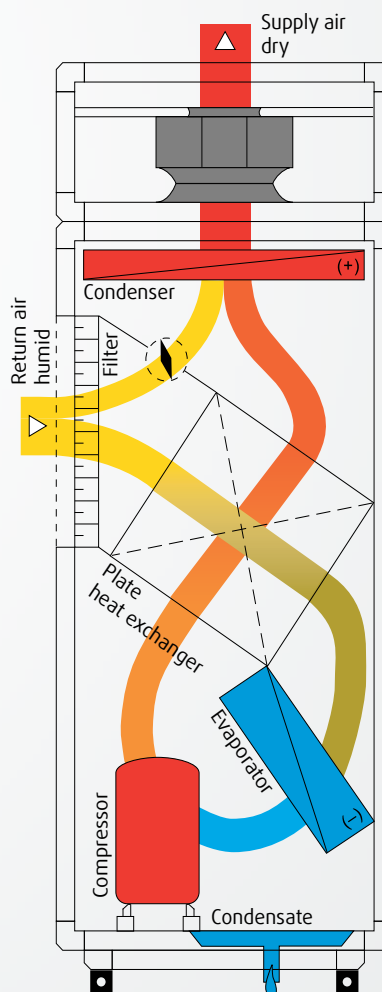

All-in-one concept: For commercial kitchens and rooms with polluted exhaust air

NX Adsolair Commercial kitchen

- Area of application:** Commercial kitchens, rooms with polluted exhaust air
- Main functions:** The integrated cleaning system reliably prevents and removes grease deposits from accumulating in the heat exchanger. A special cleaning fluid is sprayed directly into the exhaust air path of the heat exchanger, which removes all residues from the plates. The three filter stages of the exhaust air installed in series separate grease, oil, aerosols, dirt, dust and odours to a large extent.
- Knowledge:** Our all-in-one concept for the ventilation of your commercial kitchen. The tasks of the NX Adsolair: Efficient and precise supply air cooling, as well as dehumidification if required, and innovative reheating of the dehumidified supply air by using the condensation heat of the cooling system. The remaining residual heat can also be used to heat the building.

Air volume flow:
2,600 – 59,600 m³/h

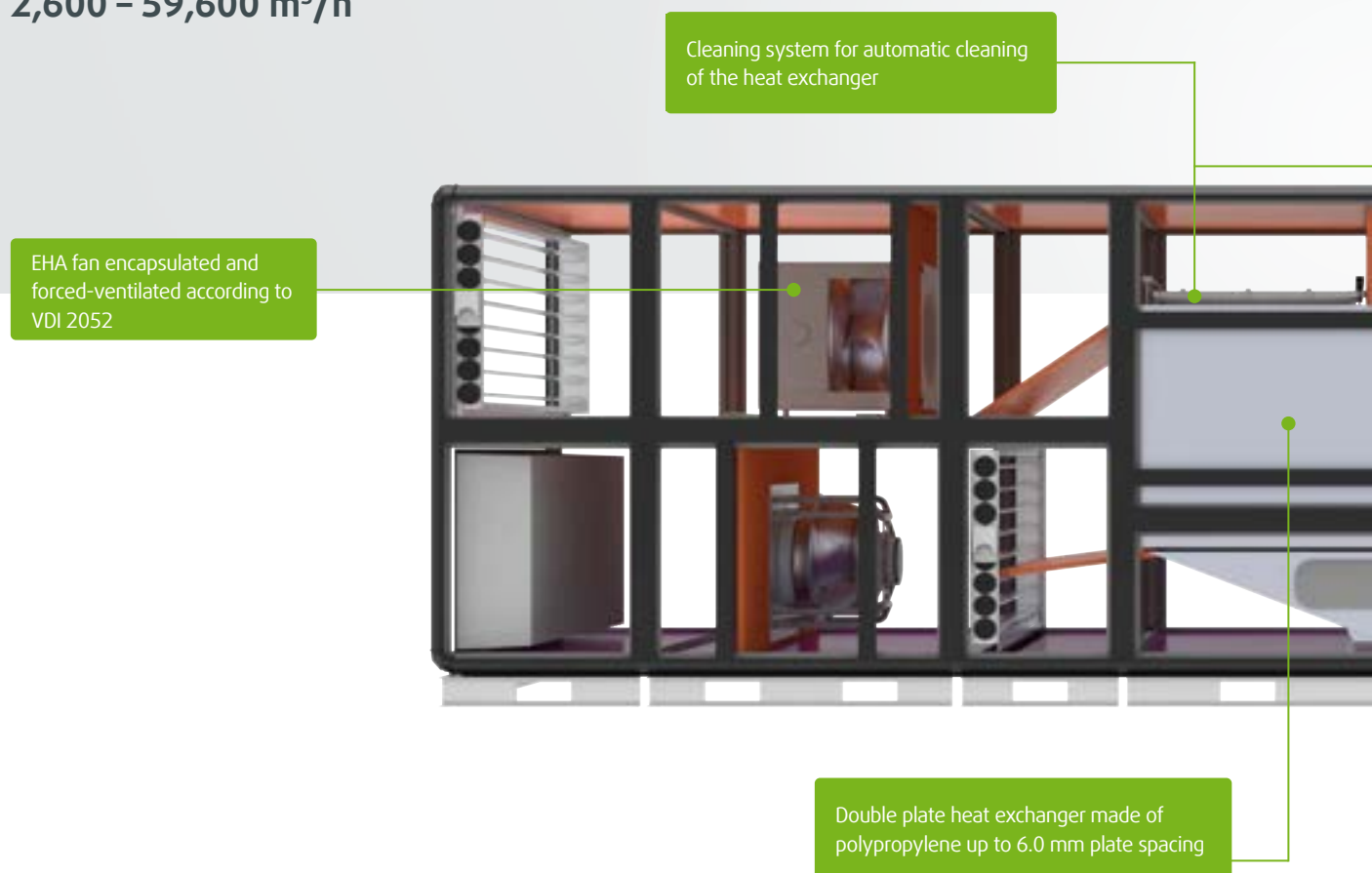

Additional details

Other included performance parameters:

- Double plate heat exchanger in which the extract air is adiabatically cooled.
- To meet comfort criteria, the adiabatically cooled supply air is additionally dehumidified by a air cooler
- Encapsulation and forced ventilation of the exhaust air fan unit
- Cleaning system that prevents the deposit of grease, oil and aerosols
- Grease collection tray is cleaned and drained via washing drains
- Triple filter
- Double plate heat exchanger, heating coil, adiabatic cooling and cooling cooler

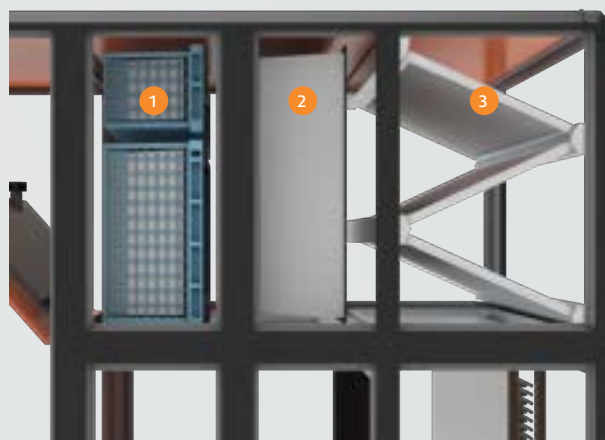

Close-up view Adsolair: Menerga triple filter

- ① Activated carbon filter
- ② Air filter
- ③ Oil/grease cassette filter for coarse separation

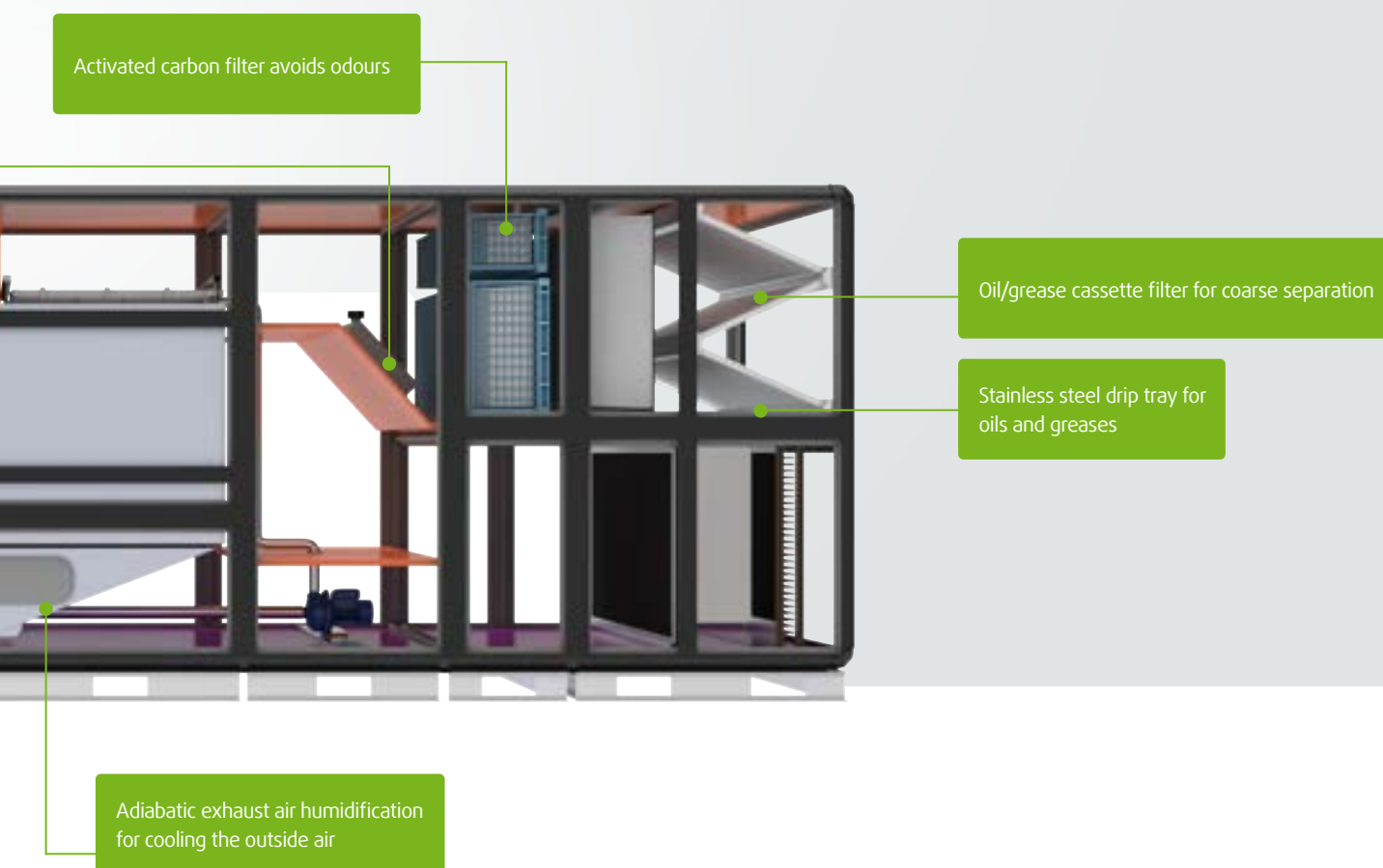





Innovation for the Future

At a glance: Orange is green

At a glance

We have been committed to environmentally friendly solutions since our inception. At Menerga, we are continuously committed to green technologies that have a positive impact on our environment. An important part of our sustainable mission is the use of natural refrigerants in our air handling units.

At Menerga, we embody the spirit of future-proofing, paving the way for a greener and more sustainable future. Our commitment to cutting-edge innovation, certified solutions, adaptability and consistent customer focus means we are well equipped to meet the ever-changing demands of the market, demanding customers and environmental regulations.

1 Use of Natural Refrigerants:
Menerga consistently employs natural refrigerants. These refrigerants have minimal environmental impact, do not contribute to ozone depletion, and have a low greenhouse effect. Avoiding fluorinated hydrocarbons (F-gases) significantly reduces the CO₂ footprint and supports the fight against climate change.

2 Energy-Efficient Technologies:
Menerga relies on state-of-the-art technologies that ensure high energy efficiency. By using advanced components and intelligent designs, customers can benefit from lower energy costs and reduced energy consumption.

3 Focus on Air Quality:
In addition to air conditioning, Menerga places special emphasis on indoor air quality. Their innovative solutions guarantee a continuous supply of fresh air and efficient removal of pollutants, creating a healthy indoor environment.

4 Sustainable Customer Solutions:
Menerga develops tailored air conditioning solutions that meet customers' individual requirements and needs. Integrating sustainability throughout every phase of the project enables customers to implement eco-friendly and long-lasting solutions.

5 Contribution to Environmental Protection:
By using natural refrigerants and energy-efficient technologies, Menerga actively contributes to environmental protection. Reducing emissions and responsible resource management are central to the company's philosophy.

6 Adaptability and Innovation:
Menerga continuously invests in research and development to create innovative solutions that align with the latest technological advancements. This adaptability allows the company to respond to changing customer needs and market conditions, positioning itself as a leading player in the industry.





Innovation
for the Future



Menerga GmbH

Alexanderstraße 38
45472 Mülheim an der Ruhr
Germany



+49 (0)208 9981-0



info@menerga.com



fb.com/menergagermany



linkedin.com/company/menerga-gmbh/

